

Care and Cleaning of Ultrasound Systems and Transducers

Contents

- 1 Read This First..... 7**
 - Warning Symbols..... 9
 - Customer Comments..... 10
 - Customer Service..... 10
 - User Information Conventions..... 11
 - Supplies and Accessories..... 12
- 2 Safety..... 13**
 - Warnings and Cautions..... 13
 - Latex Product Alert..... 17
 - FDA Medical Alert on Latex..... 18
 - Infection Control..... 19
 - Transmissible Spongiform Encephalopathy..... 21
 - Transducer Covers..... 21
- 3 Disinfectants for Systems and Transducers..... 25**
 - About Disinfectants..... 25
 - Factors Affecting Disinfectant Efficacy..... 27
 - Choosing Disinfectants and Cleaners..... 27
- 4 System Cleaning and Maintenance..... 31**
 - Disinfectants and Cleaners for System Surfaces..... 31
 - Cleaning and Disinfecting the System and ECG Equipment..... 34
 - Cleaning the System and ECG Equipment..... 36
 - Disinfecting System Surfaces and ECG Equipment..... 37
 - Lumify System Maintenance..... 38
 - Cleaning the Trackball..... 38

4535 620 14051_A/795 * JUL 2019

Philips

Cleaning the System Air Filter.....	38
Cleaning and Disinfecting the AC Adapter.....	40
5 Transducer Care.....	41
Definitions for Cleaning, Disinfection, and Sterilization of Transducers.....	41
Transducer Care Methods.....	43
Guidelines for ARs (Automated Reprocessors).....	45
Guidelines for Automated TEE Transducer Disinfectors and Cleaner Disinfectors.....	47
Non-TEE Transducer Care.....	49
Warnings and Cautions for Non-TEE Transducers.....	51
Cleaning Non-TEE Transducers, Cables, and Connectors.....	57
Low-Level Disinfecting Non-TEE Transducers.....	60
High-Level Disinfecting Non-TEE Transducers.....	62
Sterilizing Non-TEE Transducers.....	66
USB Transducer Care.....	69
Warnings and Cautions for USB Transducers.....	70
Cleaning USB Transducers, Cables, and Connectors.....	75
Low-Level Disinfecting USB Transducers.....	79
High-Level Disinfecting USB Transducers.....	81
Sterilizing USB Transducers.....	84
TEE Transducer Care.....	84
Warnings and Cautions for TEE Transducers.....	86
Guidelines for TEE Transducers.....	93
Cleaning and Disinfecting TEE Transducers.....	96
Cleaning the TEE Transducer, Cable, Connector, and Handle.....	97
Low-Level Disinfecting TEE Cable, Connector, and Handle.....	101
High-Level Disinfecting and Sterilizing TEE Transducers (Flexible Shaft and Distal Tip).....	102
Ultrasound Transmission Gels.....	105
6 Transducer Storage and Transport.....	107
Transducer Transport.....	107
Storage for Transport.....	107

Daily and Long-Term Storage..... 108

4535 620 14051_A/795 * JUL 2019

Philips

1 Read This First

The user information for your Philips product describes the most extensive configuration of the product, with the maximum number of options and accessories. Some functions described may be unavailable on your product's configuration.

Transducers are available only in countries or regions where they are approved. For information specific to your region, contact your local Philips representative.

Ultrasound systems and transducers require proper care, cleaning, and handling. Reasonable care includes inspection, cleaning, and disinfection or sterilization, as necessary. This manual contains information and instructions to help you effectively clean, disinfect, and sterilize your Philips ultrasound system and transducers. Additionally, these instructions help avoid damage during cleaning, disinfection, and sterilization, which could void your warranty.

The information in this manual is applicable to the following ultrasound systems:

- Affiniti series
- ClearVue series
- CX30
- CX50
- EPIQ series
- HD5
- HD6
- HD7
- HD11 series
- HD15
- iE33
- iU22
- Lumify
- Sparq
- Xperius (distributed by B. Braun)

For information about Philips ultrasound systems or transducers that are not specifically mentioned in this document, see your system's *User Manual*, which contains information that is specific to your system and transducers.

Before you attempt to clean or disinfect a system or its transducers, read this manual and strictly observe all warnings and cautions. Pay special attention to the information in the "Safety" section.

For a list of disinfectants and cleaners that are compatible with your Philips ultrasound system and transducers, see *Disinfectants and Cleaning Solutions for Ultrasound Systems and Transducers* (available with your system documentation) or the "Transducer and System Care" website:

www.philips.com/transducercare

For a list of the transducers supported by your system, see your system *User Manual* and *User Information Update* (if applicable), which contain information that is specific to your system and transducers.

For more information:

- In North America, call Philips at 800-722-9377.
- Outside North America, contact your local Philips representative.
- Visit the "Transducer and System Care" website:

www.philips.com/transducercare

This document or digital media and the information contained in it is proprietary and confidential information of Philips and may not be reproduced, copied in whole or in part, adapted, modified, disclosed to others, or disseminated without the prior written permission of the Philips Legal Department. This document or digital media is intended to be used either by customers, and is licensed to them as part of their Philips equipment purchase, or to meet regulatory commitments as required by the FDA under 21 CFR 1020.30 (and any amendments to it) and other local regulatory requirements. Use of this document by unauthorized persons is strictly prohibited.

Philips provides this document without warranty of any kind, implied or expressed, including, but not limited to, the implied warranties of merchantability and fitness for a particular purpose.

Philips has taken care to ensure the accuracy of this document. However, Philips assumes no liability for errors or omissions and reserves the right to make changes without further notice to any products herein to improve reliability, function, or design. Philips may make improvements or changes in the products or programs described in this document at any time.

Philips makes no representation or warranty to the user or any other party with respect to the adequacy of this document for any particular purpose or with respect to its adequacy to produce a particular result. The user's right to recover damages caused by fault or negligence on the part of Philips shall be limited to the amount paid by the user to Philips for the provision of this document. In no event shall Philips be liable for special, collateral, incidental, direct, indirect or consequential damage, losses, costs, charges, claims, demands, or claims for lost profits, data, fees, or expenses of any nature or kind.

Unauthorized copying of this document, in addition to infringing copyright, might reduce the ability of Philips to provide accurate and current information to users.

"xMATRIX" is a trademark of Koninklijke Philips N.V.



"Xperius" is a trademark jointly owned by Koninklijke Philips N.V. and B. Braun Melsungen AG.



Non-Philips product names may be trademarks of their respective owners.

Warning Symbols

The system may use the following warning symbols. For additional symbols used on the system, see the "Safety" section in your system *User Manual* and *User Information Update*, if applicable.

Warning Symbols

Symbol	Description
	Identifies a safety message.
	Dangerous voltages: Appears adjacent to high-voltage terminals, indicating the presence of voltages greater than 1,000 Vac (600 Vac in the United States).

Symbol	Description
	Identifies ESD (electrostatic-discharge) sensitivity of a connector that is not tested as specified in IEC 60601-1-2. Do not touch exposed connector pins. Touching exposed pins can cause electrostatic discharge, which can damage the product.
	Indicates that the user should see the instructions for use for safety information.

Customer Comments

If you have questions about the user information, or you discover an error in the user information, in the USA, please call Philips at 800-722-9377; outside the USA, please call your local Philips customer service representative.

Customer Service

Customer service representatives are available worldwide to answer questions and to provide maintenance and service. Please contact your local Philips representative for assistance. You can also contact the following office for referral to a customer service representative, or visit this "Contact Us" website:

www.healthcare.philips.com/main/about/officelocator/index.wpd

Philips Ultrasound, Inc.

22100 Bothell Everett Hwy, Bothell, WA 98021-8431, USA

800-722-9377

User Information Conventions

The user information for your product uses the following typographical conventions to assist you in finding and understanding information:

- All procedures are numbered, and all subprocedures are lettered. You must complete steps in the sequence they are presented to ensure success.
- Bulleted lists indicate general information about a particular function or procedure. They do not imply a sequential procedure.
- The left side of the system is to your left as you stand in front of the system, facing the system. The front of the system is nearest to you as you operate it.
- Transducers and pencil probes both are referred to as transducers, unless the distinction is important to the meaning of the text.

Information that is essential for the safe and effective use of your product appears throughout your user information as follows:



WARNING

Warnings highlight information vital to the safety of you, the operator, and the patient.



CAUTION

Cautions highlight ways that you could damage the product and consequently void your warranty or service contract or ways that you could lose patient or system data.

NOTE

Notes bring your attention to important information that will help you operate the product more effectively.

Supplies and Accessories

For information on ordering supplies and accessories, see your system *User Manual*.

2 Safety

Read the information included in this section to ensure the safety of all persons operating and maintaining ultrasound equipment, all patients participating in exams, and to ensure the quality of the system and its accessories.

Safety information that applies only to a specific cleaning or disinfection task is included in the procedure for that task.

Warnings and Cautions

For maximum safety when using cleaners and disinfectants, observe the following warnings and cautions:



WARNING

Not all disinfectants are effective against all types of contamination. Ensure that the disinfectant type is appropriate for the specified system or transducer and that the solution strength and duration of contact are appropriate for the intended clinical use.



WARNING

Disinfectants are recommended because of their chemical compatibility with product materials, not their biological effectiveness. For the biological effectiveness of a disinfectant, see the guidelines and recommendations of the disinfectant manufacturer, the U.S. Food and Drug Administration, and the U.S. Centers for Disease Control.

**WARNING**

The level of disinfection required for a device is dictated by the type of tissue it will contact during use and the type of transducer being used. Ensure that the disinfectant type is appropriate for the type of transducer and the transducer application. For information on the levels of disinfection requirements, see [“Transducer Care Methods” on page 43](#). Also, see the disinfectant label instructions and the recommendations of the Association for Professionals in Infection Control, the U.S. Food and Drug Administration, the AIUM Official Statements: "Guidelines for Cleaning and Preparing External- and Internal-Use Ultrasound Transducers Between Patients, Safe Handling, and Use of Ultrasound Coupling Gel," and the U.S. Centers for Disease Control.

**WARNING**

When sterilizing a transducer, ensure that the sterilant's strength and duration of contact are appropriate for sterilization. Be sure to follow the manufacturer's instructions.

**WARNING**

If a pre-mixed solution is used, be sure to observe the solution expiration date.

**WARNING**

Follow the recommendations of the cleaner or disinfectant manufacturer.

**WARNING**

To avoid risk of electrical shock, do not use any transducer that has been immersed beyond the specified cleaning or disinfection level.

**CAUTION**

Do not use abrasive cleaners, or acetone, MEK, paint thinner, or other strong solvents on the system, peripherals, or transducers.

**CAUTION**

Do not use Sani-Cloth AF3 or Super Sani-Cloth to disinfect the system.

**CAUTION**

On monitor screens, do not use glass cleaners, Dispatch spray, or products containing bleach. Repeated use of such cleaners or products may damage the monitor screen surface. Immediately wipe away approved disinfectants or cleaners to prevent residue buildup. Use cleaners specifically designed for cleaning LCDs or OLEDs.

**CAUTION**

On touch screens, do not use Dispatch spray or products containing bleach or alcohol. Repeated use of such cleaners or products may damage the touch screen surface. Immediately wipe away approved disinfectants or cleaners to prevent residue buildup.

**CAUTION**

On monitor screens and touch screens, use microfiber cloth; do not use paper towels.

**CAUTION**

System surfaces and transducers are resistant to ultrasound gel, alcohol, and disinfectants, but if you use those substances, you must wipe them off to prevent permanent damage.

**CAUTION**

Using non-recommended disinfectants, using incorrect solution strengths, or immersing a transducer deeper or longer than recommended can damage or discolor the transducer and voids the transducer warranty.

**CAUTION**

The use of isopropyl alcohol (rubbing alcohol), denatured ethyl alcohol, and alcohol-based products on all transducers is limited. On transducers with USB connectors, the only parts that may be cleaned with alcohol are the transducer housing and lens (acoustic window). On non-TEE transducers, the only parts that may be cleaned with alcohol are the connector housing and the transducer housing and lens. On TEE transducers, the only parts that may be cleaned with alcohol are the connector housing and the control housing. Ensure that the solution is only 91% or less isopropyl alcohol or 85% or less denatured ethyl alcohol. Do not clean any other part of a transducer with alcohol (including cables, USB connectors, or strain reliefs), because it can damage those parts of the transducer. This damage is not covered by the warranty or your service contract.

**CAUTION**

Some cleaning and disinfectant products may result in discoloration if residual disinfectant and gel have not been completely removed between each use. Always remove gel completely before using cleaners and disinfectants. If necessary, where compatible for use, 70% isopropyl alcohol may be used to remove residue buildup on system components. If necessary, where compatible for use, 91% or less isopropyl alcohol solutions or 85% or less denatured ethyl alcohol solutions may be used to remove residue buildup on some transducer components.

**CAUTION**

Do not apply adhesive films, such as Tegaderm, to the transducer lens. Application of such films can damage the lens.

Latex Product Alert

Philips ultrasound systems and transducers do not contain natural rubber latex that contacts humans.

**WARNING**

Transducer covers can contain natural rubber latex, which may cause allergic reactions in some individuals.

**WARNING**

The M2203A bite guard strap contains natural rubber latex, which may cause allergic reactions.

FDA Medical Alert on Latex

March 29, 1991, Allergic Reactions to Latex-Containing Medical Devices

Because of reports of severe allergic reactions to medical devices containing latex (natural rubber), the FDA is advising health care professionals to identify their latex sensitive patients and be prepared to treat allergic reactions promptly. Patient reactions to latex have ranged from contact urticaria to systemic anaphylaxis. Latex is a component of many medical devices, including surgical and examination gloves, catheters, intubation tubes, anesthesia masks, and dental dams.

Reports to the FDA of allergic reactions to latex-containing medical devices have increased lately. One brand of latex cuffed enema tips was recently recalled after several patients died as a result of anaphylactoid reactions during barium enema procedures. More reports of latex sensitivity have also been found in the medical literature. Repeated exposure to latex both in medical devices and in other consumer products may be part of the reason that the prevalence of latex sensitivity appears to be increasing. For example, it has been reported that 6% to 7% of surgical personnel and 18% to 40% of spina bifida patients are latex sensitive.

Proteins in the latex itself appear to be the primary source of the allergic reactions. Although it is not now known how much protein is likely to cause severe reactions, the FDA is working with manufacturers of latex-containing medical devices to make protein levels in their products as low as possible.

FDA's recommendations to health professionals in regard to this problem are as follows:

- When taking general histories of patients, include questions about latex sensitivity. For surgical and radiology patients, spina bifida patients and health care workers, this recommendation is especially important. Questions about itching, rash or wheezing after wearing latex gloves or inflating a toy balloon may be useful. Patients with positive histories should have their charts flagged.
- If latex sensitivity is suspected, consider using devices made with alternative materials, such as plastic. For example, a health professional could wear a non-latex glove over the latex glove if the patient is sensitive. If both the health professional and the patient are sensitive, a latex middle glove could be used. (Latex gloves labeled "Hypoallergenic" may not always prevent adverse reactions.)

- Whenever latex-containing medical devices are used, especially when the latex comes in contact with mucous membranes, be alert to the possibility of an allergic reaction.
- If an allergic reaction does occur and latex is suspected, advise the patient of a possible latex sensitivity and consider an immunologic evaluation.
- Advise the patient to tell health professionals and emergency personnel about any known latex sensitivity before undergoing medical procedures. Consider advising patients with severe latex sensitivity to wear a medical identification bracelet.

The FDA is asking health professionals to report incidents of adverse reactions to latex or other materials used in medical devices. (See the October 1990 FDA Drug Bulletin.) To report an incident, contact the FDA Problem Reporting Program, MedWatch, at 1-800-332-1088, or on the Internet:

www.fda.gov/Safety/MedWatch/

For a single copy of a reference list on latex sensitivity, write to: LATEX, FDA, HFZ-220, Rockville, MD 20857.

Infection Control

Issues related to infection control affect the operator and the patient. Follow the infection-control procedures established in your facility for the protection of both the staff and the patient.

Handling Contaminated Transducers

The primary area of concern is the handling of transducers that have contacted infected patients. Always wear gloves when you handle transducers used in TEE, endocavity, intraoperative, and biopsy procedures that have not been previously disinfected. For information on cleaning and disinfecting transducers, see the “[Transducer Care](#)” section.

Removing Blood and Infectious Material from the System



WARNING

If the system becomes contaminated internally with bodily fluids carrying pathogens, you must immediately notify your Philips service representative. Components inside the system cannot be disinfected. In that case, the system must be disposed of as biohazardous material in accordance with local or federal laws.



CAUTION

The use of isopropyl alcohol (rubbing alcohol), denatured ethyl alcohol, and alcohol-based products on all transducers is limited. On transducers with USB connectors, the only parts that may be cleaned with alcohol are the transducer housing and lens (acoustic window). On non-TEE transducers, the only parts that may be cleaned with alcohol are the connector housing and the transducer housing and lens. On TEE transducers, the only parts that may be cleaned with alcohol are the connector housing and the control housing. Ensure that the solution is only 91% or less isopropyl alcohol or 85% or less denatured ethyl alcohol. Do not clean any other part of a transducer with alcohol (including cables, USB connectors, or strain reliefs), because it can damage those parts of the transducer. This damage is not covered by the warranty or your service contract.

Use a gauze pad moistened with soap and potable water to remove blood on the system and the transducer connectors and cables. Then dry the equipment with a soft, dry, lint-free cloth to prevent corrosion. You can use a 70% solution of isopropyl alcohol only on certain parts of the system. For compatible system components, see [“Disinfectants and Cleaners for System Surfaces” on page 31](#). You can use a 91% isopropyl alcohol solution or an 85% denatured ethyl alcohol solution only on certain parts of transducers. For more information, see the section for each type of transducer. Additional cleaning agents are available. For more

information, see *Disinfectants and Cleaning Solutions for Ultrasound Systems and Transducers*. For more information about removing blood and other infectious material from the system, see the “[System Cleaning and Maintenance](#)” section.

ECG Cables and Lead Sets

For information on cleaning ECG cables and lead sets, see the “[System Cleaning and Maintenance](#)” section.

Transmissible Spongiform Encephalopathy



WARNING

If a sterile transducer cover becomes compromised during an intraoperative application involving a patient with transmissible spongiform encephalopathy, such as Creutzfeldt-Jakob disease, follow the guidelines of the U.S. Centers for Disease Control and this document from the World Health Organization: WHO/CDS/ APH/2000/3, WHO Infection Control Guidelines for Transmissible Spongiform Encephalopathies. The transducers for your system cannot be decontaminated using a heat process.

Transducer Covers

To prevent contamination by blood-borne pathogens, sterile transducer covers are required for needle guidance procedures. Philips and B. Braun recommend the use of qualified covers.

For procedures for using transducer covers, see the instructions provided with the covers.

**WARNING**

Latex and talc are commonly used in sheaths marketed to help with infection control in transesophageal, endocavity, and intraoperative imaging applications and during needle guidance and biopsies. Examine the packaging to confirm latex and talc content. Studies have shown that patients can experience allergic reactions with natural rubber latex. See the FDA Medical Alert, March 29, 1991, reprinted in [“FDA Medical Alert on Latex” on page 18.](#)

**WARNING**

In intraoperative applications, sterilized transducers should be used with sterile gel and a sterile transducer cover.

**WARNING**

Inspect transducer covers before and after use.

**WARNING**

Do not apply the transducer cover until you are ready to perform the procedure.

**WARNING**

If an installed transducer cover is cut or contaminated before use, the transducer should be cleaned and disinfected, and a new sterile cover installed.



WARNING

Sterile transducer covers are disposable and must not be reused.

3 Disinfectants for Systems and Transducers

Read this information before performing disinfection and sterilization procedures. It discusses recommended disinfectants and choosing an appropriate disinfectant for the required level of disinfection. You must refer to the appropriate disinfectants and cleaners compatibility table for the chemical compatibility of disinfectants and cleaners for Philips ultrasound transducers (see *Disinfectants and Cleaning Solutions for Ultrasound Systems and Transducers*).

About Disinfectants



WARNING

Not all disinfectants are effective against all types of contamination. Ensure that the disinfectant type is appropriate for the specified system or transducer and that the solution strength and duration of contact are appropriate for the intended clinical use.



WARNING

Disinfectants are recommended because of their chemical compatibility with product materials, not their biological effectiveness. For the biological effectiveness of a disinfectant, see the guidelines and recommendations of the disinfectant manufacturer, the U.S. Food and Drug Administration, and the U.S. Centers for Disease Control.



WARNING

If a pre-mixed solution is used, be sure to observe the solution expiration date.

**WARNING**

Always use protective eyewear and gloves when cleaning, disinfecting, or sterilizing any equipment.

**WARNING**

The level of disinfection required for a device is dictated by the type of tissue it will contact during use and the type of transducer being used. Ensure that the disinfectant type is appropriate for the type of transducer and the transducer application. For information on the levels of disinfection requirements, see [“Transducer Care Methods” on page 43](#). Also, see the disinfectant label instructions and the recommendations of the Association for Professionals in Infection Control, the U.S. Food and Drug Administration, the AIUM Official Statements: "Guidelines for Cleaning and Preparing External- and Internal-Use Ultrasound Transducers Between Patients, Safe Handling, and Use of Ultrasound Coupling Gel," and the U.S. Centers for Disease Control.

**CAUTION**

Using non-recommended disinfectants, using incorrect solution strengths, or immersing a transducer deeper or longer than recommended can damage or discolor the transducer and voids the transducer warranty.

**CAUTION**

The use of isopropyl alcohol (rubbing alcohol), denatured ethyl alcohol, and alcohol-based products on all transducers is limited. On transducers with USB connectors, the only parts that may be cleaned with alcohol are the transducer housing and lens (acoustic window). On non-TEE transducers, the only parts that may be cleaned with alcohol are the connector housing and the transducer housing and lens. On TEE transducers, the only parts that may be cleaned with alcohol are the connector housing and the control housing. Ensure that the solution is only 91% or less isopropyl alcohol or 85% or less denatured ethyl alcohol. Do not clean any other part of a transducer with alcohol (including cables, USB connectors, or strain reliefs), because it can damage those parts of the transducer. This damage is not covered by the warranty or your service contract.

Factors Affecting Disinfectant Efficacy

The following factors will affect the efficacy of a disinfectant:

- Number and location of microorganisms
- Innate resistance of microorganisms
- Concentration and potency of disinfectants
- Physical and chemical factors
- Organic and inorganic matter
- Duration of exposure
- Biofilms

Choosing Disinfectants and Cleaners

To choose the disinfectant and cleaners that are compatible with your Philips ultrasound system and transducers, see *Disinfectants and Cleaning Solutions for Ultrasound Systems and Transducers*, which is available with your system documentation or on the “Transducer and System Care” website:

www.philips.com/transducercare

Follow the label instructions for preparation and solution strength. If a pre-mixed solution is used, be sure to observe the solution expiration date.

Because of the large number of available cleaning and disinfection products, it is impossible to have an all-inclusive list. If you are unsure of the suitability of a particular product, please contact your Philips representative for assistance.

For more information:

- www.philips.com/transducercare
- In North America, call Philips at 800-722-9377.
- Outside North America, contact your local Philips representative.

Based on material-compatibility testing, product-use profile, and active ingredients, Philips has generically approved for use the following types of *low-level* and *intermediate-level* disinfectants used as a spray or wipe for surface (skin contact) and transvaginal or transrectal transducers, according to the compatibility restrictions in the disinfectants table.



CAUTION

Philips has not generically approved for use the following on transesophageal or laparoscopic transducers.

- Sodium-hypochlorite based (for example 10% household bleach solution with active sodium hypochlorite at approximately 0.6%)
- Quaternary-ammonium (QUAT) based (for example, products that contain n-alkyl xbenzyl ammonium chloride solution where x can be any organic functional group such as ethyl and methyl, and so on; concentration at use should be less than 0.8% total for all QUATs listed)
- Accelerated hydrogen-peroxide based (0.5% hydrogen peroxide maximum)
- Alcohol or alcohol-plus-QUAT based (product alcohol content cannot exceed 91% isopropyl alcohol or 85% denatured ethyl alcohol)

- Products not specifically listed in the compatibility table but with similar active ingredients, as indicated in this list, and marketed for medical use

4 System Cleaning and Maintenance

Maintenance should be performed regularly and as needed.

Because the system is a piece of medical equipment that contains several circuit boards, extensive service diagnostics, and complex operating software, Philips recommends that only trained personnel service the system.

It is important to clean and maintain the ultrasound system and peripherals. Thorough cleaning is important for pieces of peripheral equipment, because they contain electromechanical devices. If exposed to constant and excessive environmental dust and humidity, these devices will suffer in both performance and reliability.

It is essential to clean the transducers used with your ultrasound system. The cleaning procedures vary for the different types of transducers and their uses. For detailed instructions on how to clean and maintain each type of transducer used with the system, see the [“Transducer Care”](#) section. For additional system-specific instructions on how to clean and maintain your system, see your system *User Manual*.



WARNING

Always use protective eyewear and gloves when cleaning, disinfecting, or sterilizing any equipment.



CAUTION

Follow all instructions provided to avoid damage during cleaning, disinfection, and sterilization. Failure to do so could void your warranty.

Disinfectants and Cleaners for System Surfaces

This information applies to all systems except for Lumify, which is covered under [“Lumify System Maintenance”](#) on page 38.

The compatibility of disinfectants and cleaners varies depending on the item on which they are used. The products in the following table are compatible with these system surfaces:

- ECG trunk cables, leads, and electrodes
- External plastic and painted surfaces of system and cart
- System control panel
- Monitor screens and touch screens
- Easy-clip transducer cable managers

Cleaning Solutions for All Surfaces	Cleaning Solutions for Monitor Screens and Touch Screens	Disinfectants for System Surfaces and Touch Screens
Mild soap solution ¹	<ul style="list-style-type: none"> • Mild soap solution¹ • Cleaners designed for LCDs or OLEDs • Purified water 	<ul style="list-style-type: none"> • 70% isopropyl alcohol (IPA) (not approved for touch screens) • Opti-Cide3 (QUAT/IPA based) • Oxivir Tb (accelerated hydrogen peroxide based) • Protex spray or wipes (compatible with EPIQ series, Affiniti series, and Xperius systems only) • Sani-Cloth HB (QUAT based) • Sani-Cloth Plus (QUAT/IPA based) • PI-Spray II (QUAT based)

1. Mild soap solutions do not contain any harsh ingredients and are not irritating to the skin. They must not contain fragrance, oils, or alcohols. Hand sanitizers are not approved for use.



CAUTION

Do not use abrasive cleaners, or acetone, MEK, paint thinner, or other strong solvents on the system, peripherals, or transducers.

**CAUTION**

Do not use Sani-Cloth AF3 or Super Sani-Cloth to disinfect the system.

**CAUTION**

Do not spill or spray liquid into any system seams, ports, or transducer receptacles.

**CAUTION**

On monitor screens and touch screens, use microfiber cloth; do not use paper towels.

**CAUTION**

On monitor screens, do not use glass cleaners, Dispatch spray, or products containing bleach. Repeated use of such cleaners or products may damage the monitor screen surface. Immediately wipe away approved disinfectants or cleaners to prevent residue buildup. Use cleaners specifically designed for cleaning LCDs or OLEDs.

**CAUTION**

On touch screens, do not use Dispatch spray or products containing bleach or alcohol. Repeated use of such cleaners or products may damage the touch screen surface. Immediately wipe away approved disinfectants or cleaners to prevent residue buildup.

**CAUTION**

System surfaces and transducers are resistant to ultrasound gel, alcohol, and disinfectants, but if you use those substances, you must wipe them off to prevent permanent damage.

For a more information about disinfectants for the system and transducers, see the [“Disinfectants for Systems and Transducers”](#) section.

For instructions on cleaning and disinfecting ultrasound systems and transducers, see the [“Transducer Care”](#) section.

Cleaning and Disinfecting the System and ECG Equipment

This information applies to all systems except for Lumify, which is covered under [“Lumify System Maintenance”](#) on page 38.

The system control panel and other outer surfaces are most likely to be affected by liquid spills and other materials such as excessive amounts of gel. These materials may seep into electrical components under the panel and cause intermittent failures. During preventive maintenance, look for potential problems including loose knobs and worn controls.

**WARNING**

Always use protective eyewear and gloves when cleaning, disinfecting, or sterilizing any equipment.

**WARNING**

The system contains high voltages and has the potential of shock during maintenance. To avoid risk of electrical shock hazards, always turn off the system, disconnect the main power cord from the wall outlet, and wait at least 30 seconds before cleaning the system.

**CAUTION**

Use only compatible cleaners and disinfectants on system surfaces. If a pre-mixed solution is used, be sure to observe the solution expiration date.

**CAUTION**

Ensure that the system brakes are locked before performing maintenance or cleaning.

**CAUTION**

Do not use abrasive cleaners, or acetone, MEK, paint thinner, or other strong solvents on the system, peripherals, or transducers.

**CAUTION**

To avoid damage to the monitor screen or touch screen, do not touch them with any sharp object such as pencils or calipers. Take care not to scratch the face of the screen while cleaning.

**CAUTION**

On monitor screens and touch screens, use microfiber cloth; do not use paper towels.

**CAUTION**

When cleaning the system control panel, monitor screens, touch screen, and keyboard, take care not to get any solution inside the housings. Do not spill or spray liquid on the controls, into the system cabinet, or into the transducer receptacles.

**CAUTION**

Do not spray disinfectant directly on system surfaces. When wiping, do not allow disinfectant to pool or run on system surfaces. In either case, disinfectant may leak into the system, damaging the system and voiding the warranty. Wipe only with a cloth or applicator that is lightly dampened.

**CAUTION**

System surfaces and transducers are resistant to ultrasound gel, alcohol, and disinfectants, but if you use those substances, you must wipe them off to prevent permanent damage.

Cleaning the System and ECG Equipment

This information applies to all systems except for Lumify, which is covered under [“Lumify System Maintenance”](#) on page 38.

1. Before cleaning, turn off the system, disconnect the power cord from the power source, and ensure that the system brakes are locked.
2. To clean monitor screens and touch screens:
 - a. Remove dust with a soft, lint-free cloth. Philips recommends using a microfiber cloth.
 - b. Use a liquid screen cleaner specifically designed for LCDs or OLEDs. Spray the liquid onto the cleaning cloth and gently wipe the screen clean. You can also use pre-moistened screen wipes.
 - c. Dry the screen with a soft, lint-free cloth.
3. To clean the control panel, remove any solid matter around the keys or the controls with a cotton swab or toothpick to ensure that solids are not pushed into the cabinet. Wipe with a soft cloth moistened with soap and potable water.
4. Wipe the remaining external surfaces of the system and the cart with a soft cloth lightly moistened (damp; not dripping) with soap and potable water:
 - Painted and plastic surfaces

- ECG trunk cables, leads, and electrodes

You may use a 70% isopropyl alcohol solution for stubborn stains or inks, and then wash with soap and potable water.

5. Gently remove any residue with a cloth lightly moistened with purified water.
6. Dry the equipment to prevent potential corrosion.

If the equipment has come in contact with blood or infectious material, see [“Disinfecting System Surfaces and ECG Equipment” on page 37](#) and [“Infection Control” on page 19](#).

Disinfecting System Surfaces and ECG Equipment

Before disinfecting the system and ECG equipment, read [“Disinfectants and Cleaners for System Surfaces” on page 31](#).

This information applies to all systems except for Lumify, which is covered under [“Lumify System Maintenance” on page 38](#).

1. Before cleaning and disinfecting, turn off the system, disconnect the power cord from the power source, and ensure that the system brakes are locked.
2. Clean the system according to the procedures in [“Cleaning the System and ECG Equipment” on page 36](#).
3. Choose a disinfectant compatible with your system and follow the label instructions for preparation, temperature, and solution strength. If a pre-mixed solution is used, be sure to observe the solution expiration date.
4. Wipe system surfaces with the disinfectant, following disinfectant label instructions for wipe durations, solution strengths, and disinfectant contact duration. Ensure the solution strength and duration of contact are appropriate for the intended clinical application.
5. Dry the equipment to prevent potential corrosion.

Lumify System Maintenance

It is your responsibility to appropriately clean and disinfect your device in accordance with the device manufacturer's instructions and with your institution's policies for cleaning and disinfecting of medical devices.



WARNING

If the Lumify-compatible smart device becomes contaminated internally with bodily fluids containing pathogens, you must immediately notify your Philips service representative. Components inside the device cannot be disinfected. In that case, the device must be disposed of as biohazardous material in accordance with local or federal laws.

Cleaning the Trackball

Cleaning the trackball regularly prolongs its useful life and prevents service calls.

1. With your fingers, unscrew the ring around the trackball.
2. Lift the trackball out of the mounting area.
3. Clean the trackball and the mounting area with a lint-free cloth or a small brush.
4. Place the ball back on the mounting area.
5. With your fingers, screw the ring back on.

Cleaning the System Air Filter

The system air filter should be inspected weekly and cleaned as needed. If you decide to clean the air filter with soap and water, you may want to install a spare filter while the other filter is drying. To order additional air filters, call Philips at 800-722-9377 (North America) or your local Philips representative (outside North America).

**WARNING**

Before performing any system maintenance or cleaning, always turn off the system and disconnect it from the power source.

**CAUTION**

Turn off power before you remove the air filter. Do not turn on power without the air filter installed.

**CAUTION**

Ensure that the air filter is dry before installing it. Installing a wet or damp air filter can damage the system.

**CAUTION**

Ensure that the system brakes are locked before you clean the air filter.

1. Locate the air filter handle.
2. Pull the air filter handle straight out, until the filter is completely removed from the system.
3. Inspect the filter. Depending on the condition of the air filter, vacuum or rinse the filter with water to clean it. If the filter is worn out, or cannot be cleaned, replace it with a spare.
4. To reinstall the filter, slide the filter into place.
5. For additional system-specific procedures, such as resetting the filter maintenance status, see your system *User Manual*.

Cleaning and Disinfecting the AC Adapter



CAUTION

Do not immerse the AC adapter.



CAUTION

Keep moisture and liquid away from the AC adapter. Do not spill or spray liquid on the adapter.

1. Before cleaning the AC adapter, disconnect it from the system and the wall outlet.
2. Wipe the AC adapter with a dry cloth. If spot cleaning is necessary, wipe with a cloth dampened with soap and water.
3. Remove any solid matter with a cotton swab or toothpick to ensure that solids are not pushed into the adapter.
4. If disinfection is necessary, wipe with an alcohol-moistened towelette or cloth.
5. Wipe the AC adapter with a dry cloth until thoroughly dry before connecting it into the system or wall outlet.

5 Transducer Care

All Philips transducers require proper care, cleaning, and handling. This section contains information and instructions to help you effectively clean, disinfect, and sterilize the transducers that are compatible with your Philips ultrasound system. Additionally, these instructions help avoid damage during cleaning, disinfection, and sterilization, which could void your warranty.

Reasonable care includes inspection, cleaning, and disinfection or sterilization, as necessary. Transducers must be cleaned after each use. Avoid allowing contaminants to dry on the transducer. You can reduce dried-on contaminants by applying an enzymatic foam spray.

Inspect all parts of the transducer carefully before each use. Check for cracks or other damage that jeopardizes the integrity of the transducer. Report any damage to your authorized service representative, and discontinue use of the transducer.

For information on the gels that are compatible with your system's transducers, see [“Ultrasound Transmission Gels” on page 105](#).

Definitions for Cleaning, Disinfection, and Sterilization of Transducers

All cleaning, disinfection, and sterilization represent a statistical reduction in the number of microbes present on a surface rather than their complete elimination. Meticulous cleaning of the transducer is the key to an initial reduction of the microbial/organic load by at least 99%. This cleaning is followed by a disinfecting procedure to ensure a high degree of protection from infectious disease transmission, even if a disposable barrier covers the transducer during use.

This document follows the recommendations provided in the AIUM Official Statements for the cleaning and disinfection of ultrasound transducers. You should review that document and also review the CDC document cited here:

- American Institute of Ultrasound in Medicine, AIUM Official Statements: "Guidelines for Cleaning and Preparing External- and Internal-Use Ultrasound Transducers Between Patients, Safe Handling, and Use of Ultrasound Coupling Gel." November 2018. AIUM website: www.aium.org/accreditation/Guidelines_Cleaning_Preparing.pdf

- Healthcare Infection Control Practices Advisory Committee, "Guideline for Disinfection and Sterilization in Healthcare Facilities, 2008." Centers for Disease Control and Prevention website: www.cdc.gov/infectioncontrol/guidelines/disinfection/

AIUM Definitions

- **Cleaning** removes visible soil (for example, organic and inorganic material) from objects and surfaces and normally is accomplished manually or mechanically using water with detergents or enzymatic products. Thorough cleaning is essential before high-level disinfection and sterilization because inorganic and organic materials that remain on the surfaces of instruments interfere with the effectiveness of these processes.
- **Disinfection** describes a process that eliminates many or all pathogenic microorganisms, except bacterial spores.
- **Low-Level Disinfection (LLD)** destroys most bacteria, some viruses, and some fungi. Low-level disinfection will not necessarily inactivate *Mycobacterium tuberculosis* or bacterial spores.
- **Intermediate-Level Disinfection (ILD)** inactivates *Mycobacterium tuberculosis*, bacteria, most viruses, most fungi, and some bacterial spores.
- **High-Level Disinfection (HLD)** destroys or removes all microorganisms except bacterial spores.
- **Sterilization** describes a process that destroys or eliminates all forms of microbial life and is carried out in healthcare facilities by physical or chemical methods. When chemicals are used to destroy all forms of microbiologic life, they can be called chemical sterilants. These same germicides used for shorter exposure periods also can be part of the disinfection process (that is, high-level disinfection).

Transducer Care Methods

To choose an appropriate care method for your transducer, you first must determine the classification of the transducer, based on its use. The care method for your transducer determines the appropriate disinfectant for your transducer. For details about compatible disinfectants, see the [“Disinfectants for Systems and Transducers”](#) section. Always follow the manufacturer’s instructions when using cleaners and disinfectants.

NOTE

Philips recommends the same level of cleaning, disinfection, and sterilization between uses, regardless of whether the next use is on the same patient or a different patient.

Care Methods by Transducer Type

Non-TEE Transducer Use	Example	Classification	Care Method
Contacts intact skin	Curved, linear, xMATRIX, and sector transducers	Noncritical	Low-level disinfection (see “Low-Level Disinfecting Non-TEE Transducers” on page 60)
Contacts mucous membranes or non-intact skin	Endocavity	Semi-critical	High-level disinfection (see “High-Level Disinfecting Non-TEE Transducers” on page 62) ¹
Enters otherwise sterile tissue	Intraoperative and laparoscopic	Critical	High-level disinfection or sterilization (see “High-Level Disinfecting Non-TEE Transducers” on page 62 or “Sterilizing Non-TEE Transducers” on page 66) ¹

USB Transducer Use	Example	Classification	Care Method
Contacts intact skin	Curved, linear, and sector USB transducers	Noncritical	Low-level disinfection (see “Low-Level Disinfecting USB Transducers” on page 79)
Contacts non-intact skin	Curved, linear, and sector USB transducers	Semi-critical	High-level disinfection or sterilization (see “High-Level Disinfecting USB Transducers” on page 81 or “Sterilizing USB Transducers” on page 84) ¹

TEE Transducer Use	Example	Classification	Care Method
Contacts mucous membranes	Transesophageal (TEE)	Semi-critical	High-level disinfection or sterilization (see “High-Level Disinfecting and Sterilizing TEE Transducers (Flexible Shaft and Distal Tip)” on page 102) ¹

1. High-level disinfection and the use of a sterile gel and a transducer cover, as described in the instructions provided with the transducer cover, is an accepted method of infection control for ultrasound transducers. See the FDA Guidance document “Information for Manufacturers Seeking Marketing Clearance of Diagnostic Ultrasound Systems and Transducers.”

Guidelines for ARs (Automated Reprocessors)

Only some transducers are compatible with an automated reprocessor (AR), and the AR can use only specific solutions or processing conditions.

You can reprocess Philips transducers in an AR if the following criteria are met:

- All chemicals and processing conditions used must be compatible with the specific Philips transducer model being reprocessed, and they must be used under the conditions recommended by the AR manufacturer.
- The temperature used during reprocessing must not exceed 55°C (131°F).
- Except when using the STERRAD 100S system, the transducer connector must be isolated from the cleaning or disinfectant solution throughout the reprocessing. This limits the risk of splashing onto the handle or connector.

The following are the ARs that meet the reprocessing requirements of specific non-TEE Philips transducers. These ARs are either specifically designed for, or provide attachments that support, specific transducer reprocessing.

NOTE

In addition to the ARs listed in the following table, if an AR meets the criteria in the preceding list, it is also approved for use.

Examples: ARs Compatible with Philips Non-TEE Transducers

Manufacturer	Country of Origin	Model	Transducer Type	Compatible Disinfectants or Methods	Processing Conditions
Advanced Sterilization Products	US	STERRAD 100S	L10-4lap	Hydrogen Peroxide	50°C (122°F)
CIVCO Medical Solutions	US	Astra VR	Endocavity ¹	Cidex OPA, Revital-Ox RESERT, MetriCide OPA Plus	32°C (89.6°F)
Germitec	FR	Antigermix S1	Multiple ²	UV-C	Ambient temperature
Medivators	US	ADVANTAGE PLUS (with optional Ultrasound Probe Hookup Kit)	Multiple ³	RAPICIDE PA Single Shot	30°C (86°F)
Nanosonics	AU	trophon EPR trophon2	Multiple ⁴	Hydrogen Peroxide	50°C (122°F)

1. For compatible transvaginal and transrectal transducers, see the specific solutions used with this automated reprocessor in the *Disinfectant and Cleaning Solutions for Ultrasound Systems and Transducers User Manual*.
2. For compatible transducers, see Antigermix S1 in the *Disinfectant and Cleaning Solutions for Ultrasound Systems and Transducers User Manual*.
3. For compatible transducers, see Advantage Plus (with optional Ultrasound Probe Hookup Kit) in the *Disinfectant and Cleaning Solutions for Ultrasound Systems and Transducers User Manual*.
4. For compatible transducers, see trophon EPR and trophon2 in the *Disinfectant and Cleaning Solutions for Ultrasound Systems and Transducers User Manual*.

Guidelines for Automated TEE Transducer Disinfectors and Cleaner Disinfectors

Only some transducers are compatible with an automated TEE transducer disinfectant or an automated TEE transducer cleaner disinfectant, and the automated device can use only specific solutions.

You can reprocess Philips TEE transducers in an automated TEE transducer disinfectant or an automated TEE transducer cleaner disinfectant if the following criteria are met:

- All chemicals and processing conditions used must be compatible with the specific Philips TEE transducer model being reprocessed, and they must be used under the conditions recommended by the reprocessor manufacturer.
- The temperature used during reprocessing must not exceed 45°C (113°F).
- The TEE transducer handle and connector must be isolated from the cleaning or disinfectant solution throughout the reprocessing, including handle support stands and sealing mechanisms. This limits the risk of splashing onto the handle or connector.
- The use of protective barriers or devices intended to isolate the handle and connector to allow the entire transducer to be completely submerged or exposed to the disinfectant solution during reprocessor use is prohibited.
- Heated drying methods may not be used.

The following table provides examples of reprocessors that meet the reprocessing requirements for Philips TEE transducers. These reprocessors are either specifically designed for, or provide attachments that support, TEE transducer reprocessing.

NOTE

In addition to the reprocessors listed in the following table, other automated TEE transducer disinfectants or automated TEE transducer cleaner disinfectants that have FDA or CE mark clearance for use with TEE transducers and that meet the criteria in the preceding list are approved for use.

Examples: Reprocessors Compatible with Philips TEE Transducers

Manufacturer	Country of Origin	Model	Transducer Type	Compatible Disinfectants or Methods	Processing Conditions
CIVCO Medical Solutions	US	Astra TEE	TEE	Cidex OPA, MetriCide OPA Plus, Revital-Ox RESERT	40°C (104°F)
CS Medical	US	TD-100 Reprocessor	TEE	TD-5 HLD, TD-8 HLD	38°C to 40°C (100.4°F to 104°F)
		TEEClean Reprocessor	TEE	TD-5 HLD, TD-8 HLD, TEEZyme Cleaner	38°C to 40°C (100.4°F to 104°F)
Germitec	FR	Antigermix E1	TEE	UV-C	Ambient temperature
Medivators	US	ADVANTAGE PLUS (with optional TEE/TOE Probe Hookup Kit)	TEE	RAPICIDE PA Single Shot	30°C (86°F)
		DSD-201 (with optional Bridge Kit)	TEE	RAPICIDE Glut, RAPICIDE PA, RAPICIDE OPA/28	30°C (86°F)

4535 620 14051_A/795 * JUL 2019

Philips

Manufacturer	Country of Origin	Model	Transducer Type	Compatible Disinfectants or Methods	Processing Conditions
		DSD EDGE (with optional Bridge Kit)	TEE	RAPICIDE PA Single Shot	30°C (86°F)
Soluscope	FR	Serie TEE	TEE	Soluscope P/ Soluscope A, Proxy P/Proxy A	40°C (104°F)

Non-TEE Transducer Care

This information applies to all non-TEE transducers except those with USB connectors. For instructions for USB transducers, see [“USB Transducer Care” on page 69](#).

The following topics explain how to clean, disinfect, and sterilize non-TEE transducers. See [“Transducer Care Methods” on page 43](#) to determine the appropriate care method for your transducer. The following figure identifies the components of non-TEE transducers.

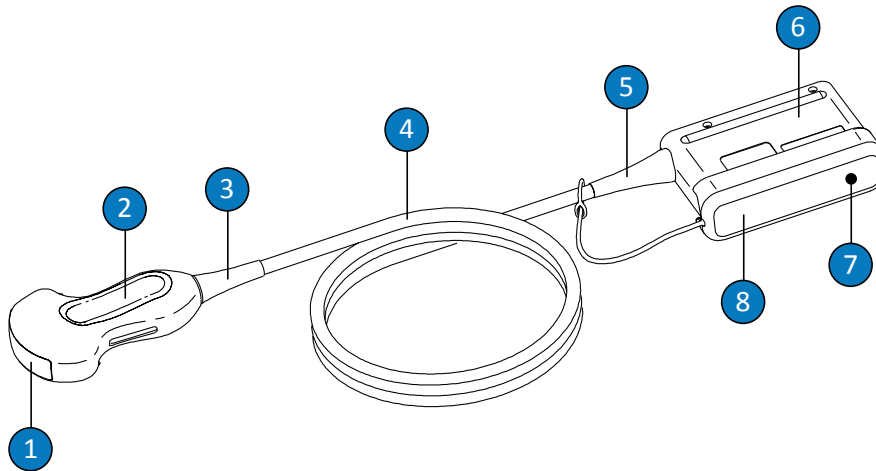

Non-TEE Transducer Components

1	Transducer lens (acoustic window)
2	Transducer housing
3	Transducer strain relief
4	Cable
5	Connector strain relief
6	Connector housing
7	Connector electrical contacts (under cover)
8	Connector cover (optional)

Warnings and Cautions for Non-TEE Transducers

Observe the following warnings and cautions during all cleaning, disinfection, and sterilization procedures, and when using disinfectants. More specific warnings and cautions are included within the care and cleaning procedures and on the labels of the cleaners or disinfectants.



WARNING

Transducers must be cleaned after each use. Cleaning the transducer is an essential step before effective disinfection or sterilization. Be sure to follow the manufacturer's label instructions when using cleaners and disinfectants.



WARNING

Always use protective eyewear and gloves when cleaning, disinfecting, or sterilizing any equipment.



WARNING

Sterile transducer covers with sterile ultrasound transmission gel are required for intraoperative and biopsy procedures. Protective covers are recommended for transesophageal, transrectal, and intravaginal procedures; in China and Japan, the covers are mandatory. Philips recommends the use of qualified covers.



WARNING

Sterile transducer covers are disposable and must not be reused.

**WARNING**

In intraoperative applications (other than TEE or endoscopy), transducers used with sterile gel and sterile transducer covers may use either the high-level disinfection or sterilization care method.

**WARNING**

Disinfectants are recommended because of their chemical compatibility with product materials, not their biological effectiveness. For the biological effectiveness of a disinfectant, see the guidelines and recommendations of the disinfectant manufacturer, the U.S. Food and Drug Administration, and the U.S. Centers for Disease Control.

**WARNING**

The level of disinfection required for a device is dictated by the type of tissue it will contact during use and the type of transducer being used. Ensure that the disinfectant type is appropriate for the type of transducer and the transducer application. For information on the levels of disinfection requirements, see [“Transducer Care Methods” on page 43](#). Also, see the disinfectant label instructions and the recommendations of the Association for Professionals in Infection Control, the U.S. Food and Drug Administration, the AIUM Official Statements: "Guidelines for Cleaning and Preparing External- and Internal-Use Ultrasound Transducers Between Patients, Safe Handling, and Use of Ultrasound Coupling Gel," and the U.S. Centers for Disease Control.

**WARNING**

When sterilizing a transducer, ensure that the sterilant's strength and duration of contact are appropriate for sterilization. Be sure to follow the manufacturer's instructions.

**WARNING**

If a pre-mixed solution is used, be sure to observe the solution expiration date.

**WARNING**

Follow the recommendations of the cleaner or disinfectant manufacturer.

**CAUTION**

Using non-recommended disinfectants, using incorrect solution strengths, or immersing a transducer deeper or longer than recommended can damage or discolor the transducer and voids the transducer warranty.

**CAUTION**

The use of isopropyl alcohol (rubbing alcohol), denatured ethyl alcohol, and alcohol-based products on all transducers is limited. On non-TEE transducers, the only parts that may be cleaned with alcohol are the connector housing and the transducer housing and lens (acoustic window). Ensure that the solution is only 91% or less isopropyl alcohol or 85% or less denatured ethyl alcohol. Do not clean any other part of a transducer with alcohol (including cables or strain reliefs), because it can damage those parts of the transducer. This damage is not covered by the warranty or your service contract.

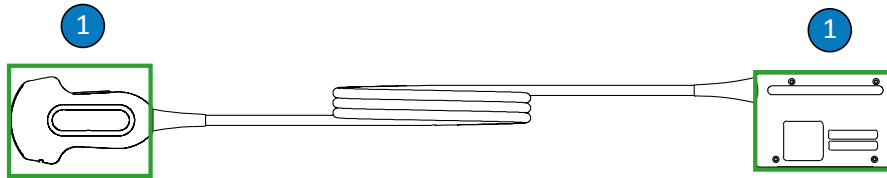

Alcohol-Compatible Non-TEE Transducer Parts

- 1 The only parts that may be cleaned with 91% or less isopropyl alcohol solutions or 85% or less denatured ethyl alcohol solutions are the connector housing and transducer housing and lens. Do not allow fluid to enter any unsealed area of the transducer. When cleaning the lens surface, use a gentle wiping motion. Aggressive wiping or scrubbing can damage the lens.



CAUTION

When using an enzymatic cleaner, be sure to use the proper concentration and rinse thoroughly. Enzymatic cleaners are generically approved for use.



CAUTION

Attempting to clean or disinfect a transducer, cable, or connector housing by using a method other than the procedures here can damage the device and voids the warranty.

**CAUTION**

Do not allow sharp objects, such as scissors, scalpels, or cauterizing knives, to touch transducers or cables.

**CAUTION**

When handling a transducer, do not bump the transducer on hard surfaces.

**CAUTION**

Do not use a surgeon's brush when cleaning transducers. Even the use of soft brushes can damage transducers.

**CAUTION**

Do not use a brush on the connector housing label.

**CAUTION**

Do not use paper products or abrasive products when cleaning a transducer. They damage the soft lens (acoustic window) of the transducer. The use of abrasive industrial wipes such as Wypall X60 can damage the lens.

**CAUTION**

During cleaning, disinfection, and sterilization, orient the parts of the transducer, connector housing, or cable that must remain dry higher than the wet parts, until all parts are dry. This helps keep liquid from entering unsealed areas of the transducer.

**CAUTION**

When cleaning and disinfecting transducers, do not allow any fluid to enter the connector through the electrical contacts, strain reliefs, connector housing, or areas surrounding the locking lever shaft. When wiping or spraying the connector, wipe or spray only the outer surfaces. If available, place a connector-cover splash guard over the electrical contacts to help prevent fluid from entering the connector housing. Damage due to fluids in these areas is not covered by the warranty or your service contract.

**CAUTION**

Never sterilize the transducer with autoclave, gamma-radiation, gas, steam, or heat sterilization techniques. Severe damage will result. Avoidable transducer damage is not covered by the warranty or service contract.

**CAUTION**

Do not expose the transducer to cleaning and disinfectant agents for extended periods of time. Limit the time that transducers are exposed to cleaning and disinfectant agents to the minimum time recommended by the manufacturer.

**CAUTION**

Before storing transducers, ensure that they are thoroughly dry. If it is necessary to dry the transducer lens (acoustic window) after cleaning, use a soft, dry, lint-free cloth and a gentle blotting motion. Aggressive wiping or scrubbing can damage the lens.

Minimizing the Effects of Residual Disinfectant

If you use an OPA (ortho-phthalaldehyde) based disinfectant, residual solution may remain on your transducers if you do not carefully follow the manufacturer's instructions.

To minimize the effects from residual OPA, or any other disinfectant, do the following:

- Follow the disinfectant manufacturer's instructions very carefully. For example, the manufacturer of Cidex OPA recommends rinsing transducers by immersing them three times in potable water.
- Limit the time that transducers are exposed to the disinfectant to the minimum time recommended by the disinfectant manufacturer. For example, the manufacturer of Cidex OPA recommends a minimum of 12 minutes.

Cleaning Non-TEE Transducers, Cables, and Connectors

These general cleaning instructions must be followed for all non-TEE transducers, cables, and connectors.

All transducers must be cleaned after each use. Cleaning the transducer is an essential step before effective disinfection or sterilization. Before cleaning a transducer, read the [“Safety”](#) section and [“Warnings and Cautions for Non-TEE Transducers”](#) on page 51.

After cleaning, you must disinfect or sterilize non-TEE transducers by following the appropriate procedures:

- [“Low-Level Disinfecting Non-TEE Transducers”](#) on page 60
- [“High-Level Disinfecting Non-TEE Transducers”](#) on page 62
- [“Sterilizing Non-TEE Transducers”](#) on page 66



WARNING

Always use protective eyewear and gloves when cleaning, disinfecting, or sterilizing any equipment.

Recommended supplies:

- Soft moist cloth or non-abrasive sponge
- Compatible cleaners or cleaning wipes for the transducer, cable, and connector

- Soft, dry, lint-free cloth
1. After every patient study, remove the ultrasound transmission gel from the transducer by using a soft moist cloth dampened with potable water or an approved cleaning or disinfectant agent or by using an approved pre-saturated cleaning or disinfectant wipe. Use a gentle wiping motion to remove gel from the lens. If applicable, remove the transducer cover.

For a list of compatible cleaning or disinfectant agents, see *Disinfectants and Cleaning Solutions for Ultrasound Systems and Transducers*, which is available with your system documentation or on the "Transducer and System Care" website:

www.philips.com/transducercare

Follow the label instructions for preparation, temperature, solution strength, and duration of contact. Ensure that the solution strength and duration of contact are appropriate for the intended clinical use of the device. If a pre-mixed solution is used, be sure to observe the solution expiration date.

2. Disconnect the transducer from the system, and remove any accessories attached to or covering the transducer. Push the connector cover, if available, onto the connector to protect against fluid splashing onto the contacts.
3. Remove any remaining gel from the transducer and lens by using running water (not to exceed 43°C (110°F)) and a soft sponge or gloved hand. If running water is not available, use a pre-moistened soft cloth, such as a flushable cleansing cloth. Use a gentle wiping motion to remove gel from the lens.

When cleaning the connector, do not allow any fluid to enter the connector through the electrical contacts, strain reliefs, connector housing, or areas surrounding the locking lever shaft. When wiping or spraying the connector, wipe or spray only the outer surfaces of the connector housing.

4. To remove any particulate matter or body fluids that remain on the transducer, cable, or connector, use commercially available cleaning wipes or sponges (enzymatic or non-enzymatic), or a soft cloth lightly dampened in a mild soap. Enzymatic cleaners are generically approved for use.

5. When cleaning the lens, use a gentle wiping motion.
6. To remove remaining particulate and cleaning residue, use cleaning wipes or sponges according to the manufacturers' instructions, or rinse thoroughly with potable water up to the immersion point shown in the figure following this procedure. Do not immerse the connector, connector strain relief, or cable that is within 5 cm (2 in) of the connector strain relief. (Up to 5 cm from the strain relief is the maximum allowable immersion point of the cable—you are not required to immerse to that point if it is unnecessary.)

NOTE

If you use cleaning wipes or sponges, it may be unnecessary to rinse the transducer with water. Always follow the product label recommendations.

7. Allow the device to air dry or use a soft, dry, lint-free cloth to dry the transducer. To dry the lens, use a blotting motion instead of a wiping motion. Wet surfaces have the potential of diluting the disinfectant.
8. Examine the device and cable for damage such as cracks, splitting, sharp edges, or projections. If damage is evident, discontinue use of the device and contact your Philips representative.

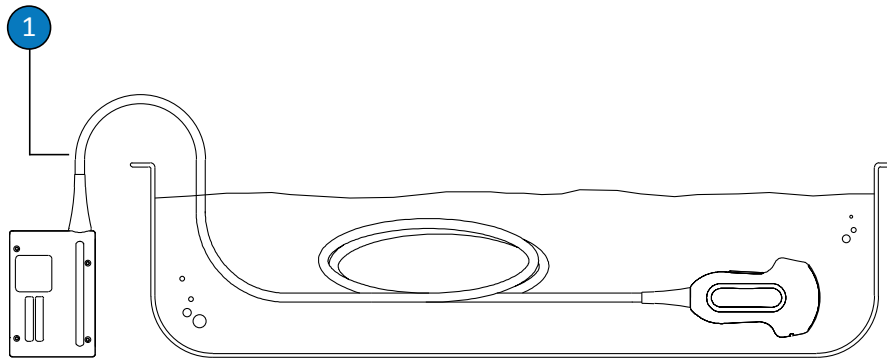

Immersion Point for Non-TEE Transducers

- 1 Do not immerse beyond this point, 5 cm (2 in) from the strain relief; this is the maximum allowable immersion of the cable—you are not required to immerse to this point if it is unnecessary.

Low-Level Disinfecting Non-TEE Transducers

Low-level disinfection of non-TEE transducers uses the spray or wipe method, with a low- or intermediate-level disinfectant. Before performing this procedure, read the warnings and cautions in the “[Safety](#)” section and “[Warnings and Cautions for Non-TEE Transducers](#)” on [page 51](#), and observe the following precautions.



WARNING

Always use protective eyewear and gloves when cleaning, disinfecting, or sterilizing any equipment.

**CAUTION**

When cleaning and disinfecting transducers, do not allow any fluid to enter the connector through the electrical contacts, strain reliefs, connector housing, or areas surrounding the locking lever shaft. When wiping or spraying the connector, wipe or spray only the outer surfaces. If available, place a connector-cover splash guard over the electrical contacts to help prevent fluid from entering the connector housing. Damage due to fluids in these areas is not covered by the warranty or your service contract.

NOTE

Transducers can be disinfected using the wipe method only if the product labeling of the compatible disinfectant that you are using indicates it can be used with a wipe method.

Recommended supplies:

- Soft moist cloth or non-abrasive sponge
 - Compatible low-level or intermediate-level disinfectants for the transducer, cable, and connector
 - Soft, dry, lint-free cloth
1. Clean the transducer, cable, and connector according to the procedures in [“Cleaning Non-TEE Transducers, Cables, and Connectors” on page 57](#). Observe all warnings and cautions.
 2. After cleaning, choose low- or intermediate-level disinfectants that are compatible with the transducer, cable, and connector.

For a list of compatible disinfectants, see *Disinfectants and Cleaning Solutions for Ultrasound Systems and Transducers*, which is available with your system documentation or on the "Transducer and System Care" website:

www.philips.com/transducercare

Follow the label instructions for preparation, temperature, solution strength, and duration of contact. Ensure that the solution strength and duration of contact are appropriate for the intended clinical use of the device. If a pre-mixed solution is used, be sure to observe the solution expiration date.

NOTE

Some products are labeled as both cleaning and disinfecting wipes. Follow label instructions for both cleaning and disinfection when using these products.

3. Wipe or spray the transducer, cable, and connector with the disinfectant, following disinfectant label instructions for temperature, wipe durations, and duration of disinfectant contact. Ensure that the disinfectant solution does not enter the connector.

When disinfecting the connector housing, wipe or spray only the outer surfaces; do not allow any type of fluid to enter through the strain relief, electrical contacts, or areas surrounding the locking lever shaft.

4. If the disinfectant label instructions require it, rinse with potable water.
5. Allow the device to air dry. You may use a soft, dry, lint-free cloth to dry the transducer. To dry the lens, use a blotting motion instead of a wiping motion.
6. Examine the transducer for damage, such as cracks, splitting, fluid leaks, or sharp edges or projections. If damage is evident, discontinue use of the transducer and contact your Philips representative.

High-Level Disinfecting Non-TEE Transducers

High-level disinfection of non-TEE transducers typically uses the immersion method with a high-level disinfectant. Automated reprocessors or other non-immersion methods can be used to disinfect some transducers. For more information, see [“Guidelines for ARs \(Automated](#)

Reprocessors)” on page 45. Before performing this procedure, read the warnings and cautions in the “Safety” section and “Warnings and Cautions for Non-TEE Transducers” on page 51, and observe the following precautions.

**WARNING**

Always use protective eyewear and gloves when cleaning, disinfecting, or sterilizing any equipment.

**CAUTION**

When cleaning and disinfecting transducers, do not allow any fluid to enter the connector through the electrical contacts, strain reliefs, connector housing, or areas surrounding the locking lever shaft. When wiping or spraying the connector, wipe or spray only the outer surfaces. If available, place a connector-cover splash guard over the electrical contacts to help prevent fluid from entering the connector housing. Damage due to fluids in these areas is not covered by the warranty or your service contract.

NOTE

Some high-level disinfectants do not require immersion and are compatible with some non-TEE transducers. For compatible high-level disinfectants, see *Disinfectants and Cleaning Solutions for Ultrasound Systems and Transducers*. If you choose to use those disinfectants, always follow the manufacturer’s instructions for use. Follow the procedures in this manual that correspond to the “Qualified Use” disinfection method for the selected disinfectant, as defined in *Disinfectants and Cleaning Solutions for Ultrasound Systems and Transducers*.

Recommended supplies:

- Soft moist cloth or non-abrasive sponge
- Compatible high-level disinfectants for the transducer and cable

- Soaking container
 - Soft, dry, lint-free cloth
1. Clean the transducer, cable, and connector according to the procedures in “[Cleaning Non-TEE Transducers, Cables, and Connectors](#)” on page 57. Observe all warnings and cautions.
 2. Disinfect the connector according to the procedures in “[Low-Level Disinfecting Non-TEE Transducers](#)” on page 60.
 3. After cleaning, choose a high-level disinfectant that is compatible with the transducer.
For a list of compatible disinfectants, see *Disinfectants and Cleaning Solutions for Ultrasound Systems and Transducers*, which is available with your system documentation or on the "Transducer and System Care" website:

www.philips.com/transducercare

Follow the label instructions for preparation, temperature, solution strength, and duration of contact. Ensure that the solution strength and duration of contact are appropriate for the intended clinical use of the device. If a pre-mixed solution is used, be sure to observe the solution expiration date.

4. Using an appropriate disinfectant for the cable, wipe or spray the cable, following disinfectant label instructions for temperature, wipe durations, solution strengths, and duration of disinfectant contact. Ensure that the disinfectant solution does not enter the connector.
5. If you are using an immersion method:
 - a. Immerse the transducer into the appropriate disinfectant for the transducer as shown in the figure following this procedure. Do not immerse the connector, connector strain relief, or cable within 5 cm (2 in) of the connector strain relief. (Up to 5 cm from the strain relief is the maximum allowable immersion point of the cable—you are not required to immerse to that point if it is unnecessary.)
 - b. Follow the instructions on the disinfectant label for the duration of transducer immersion. Do not immerse transducers longer than the minimum time needed for your level of disinfection.

- c. Using the instructions on the disinfectant label, rinse the transducer up to the point of immersion. Do not immerse the connector, connector strain relief, or cable within 5 cm (2 in) of the connector strain relief. (Up to 5 cm from the strain relief is the maximum allowable immersion point of the cable—you are not required to immerse to that point if it is unnecessary.)
6. If you are using a non-immersion method such as an AR, follow the manufacturer's instructions for use for proper cleaning and disinfection.
7. Allow the device to air dry or use a soft, dry, lint-free cloth to dry the transducer. To dry the lens, use a blotting motion instead of a wiping motion.
8. Examine the transducer for damage, such as cracks, splitting, fluid leaks, or sharp edges or projections. If damage is evident, discontinue use of the transducer and contact your Philips representative.

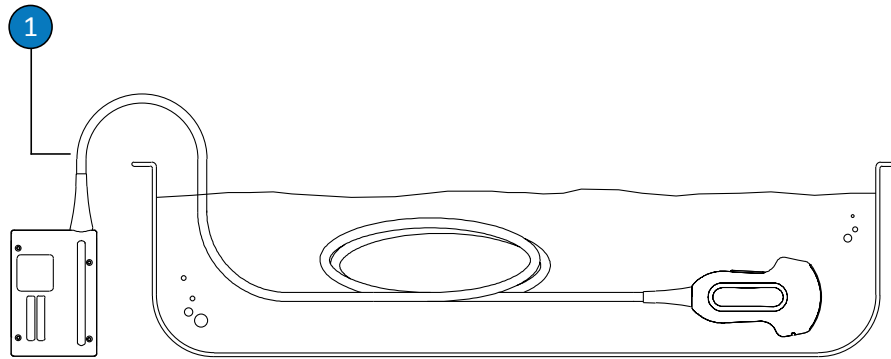

Immersion Point for Non-TEE Transducers

- 1 Do not immerse beyond this point, 5 cm (2 in) from the strain relief; this is the maximum allowable immersion of the cable—you are not required to immerse to this point if it is unnecessary.

Sterilizing Non-TEE Transducers

Sterilization is required if the transducer enters otherwise sterile tissue without a sterile cover. If you use a sterile cover, sterilization is still recommended, but high-level disinfection is acceptable. The main difference between sterilization and high-level disinfection is the length of time that the transducer is immersed and the type of disinfectant or sterilant that is used.

To determine if your transducer requires sterilization or high-level disinfection, see [“Transducer Care Methods” on page 43](#).

Before performing this procedure, read the warnings and cautions in the [“Safety” section](#) and [“Warnings and Cautions for Non-TEE Transducers” on page 51](#).



WARNING

Always use protective eyewear and gloves when cleaning, disinfecting, or sterilizing any equipment.



CAUTION

Never sterilize the transducer with autoclave, gamma-radiation, gas, steam, or heat sterilization techniques. Severe damage will result. Avoidable transducer damage is not covered by the warranty or service contract.



CAUTION

When cleaning and disinfecting transducers, do not allow any fluid to enter the connector through the electrical contacts, strain reliefs, connector housing, or areas surrounding the locking lever shaft. When wiping or spraying the connector, wipe or spray only the outer surfaces. If available, place a connector-cover splash guard over the electrical contacts to help prevent fluid from entering the connector housing. Damage due to fluids in these areas is not covered by the warranty or your service contract.

Recommended supplies:

- Soft moist cloth or non-abrasive sponge
 - Compatible sterilant for the transducer and cable
 - Soaking container
 - Soft, dry, lint-free, sterile cloth
1. Clean the transducer, cable, and connector according to the procedures in “[Cleaning Non-TEE Transducers, Cables, and Connectors](#)” on page 57.
 2. Disinfect the connector according to the procedures in “[Low-Level Disinfecting Non-TEE Transducers](#)” on page 60.
 3. After cleaning, choose the sterilant that is compatible with the transducer.

For a list of compatible disinfectants and sterilants, see *Disinfectants and Cleaning Solutions for Ultrasound Systems and Transducers*, which is available with your system documentation or on the "Transducer and System Care" website:

www.philips.com/transducercare

Follow the label instructions for preparation, temperature, solution strength, and duration of contact. Ensure that the solution strength and duration of contact are appropriate for the intended clinical use of the device. If a pre-mixed solution is used, be sure to observe the solution expiration date.

4. Using an appropriate disinfectant for the cable, wipe or spray the cable, following disinfectant label instructions for temperature, wipe durations, solution strengths, and duration of disinfectant contact. Ensure that the disinfectant solution does not enter the connector.
5. If you are using an immersion method:
 - a. Immerse the transducer in the sterilization solution as shown in the figure following this procedure. Do not immerse the connector, connector strain relief, or cable within 5 cm (2 in) of the connector strain relief. (Up to 5 cm from the strain relief is the maximum allowable immersion point of the cable—you are not required to immerse to that point if it is unnecessary.)

- b. Follow the instructions on the sterilant label for the duration of transducer immersion required for sterilization.
 - c. Remove the transducer from the sterilization solution after the recommended sterilization time has elapsed.
 - d. Using the instructions on the sterilant label, rinse the transducer in sterile water up to the point of immersion. Do not immerse the connector, connector strain relief, or cable within 5 cm (2 in) of the connector strain relief. (Up to 5 cm from the strain relief is the maximum allowable immersion point of the cable—you are not required to immerse to that point if it is unnecessary.)
6. If you are using a non-immersion method such as an AR, follow the manufacturer's instructions for use for proper cleaning and sterilization.
 7. Allow the device to air dry or use a soft, dry, lint-free, sterile cloth to dry the transducer. To dry the lens, use a blotting motion instead of a wiping motion.
 8. Examine the transducer for damage, such as cracks, splitting, fluid leaks, or sharp edges or projections. If damage is evident, discontinue use of the transducer, and contact your Philips representative.

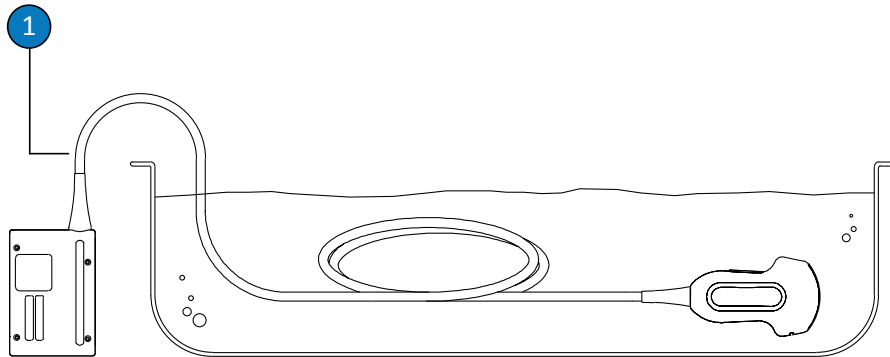

Immersion Point for Non-TEE Transducers

-
- 1 Do not immerse beyond this point, 5 cm (2 in) from the strain relief; this is the maximum allowable immersion of the cable—you are not required to immerse to this point if it is unnecessary.
-

USB Transducer Care

The following topics explain how to clean, disinfect, and sterilize transducers with USB connectors. To determine the appropriate care method for your transducer, see [“Transducer Care Methods” on page 43](#). The following figure identifies the components of a transducer with a USB connector.

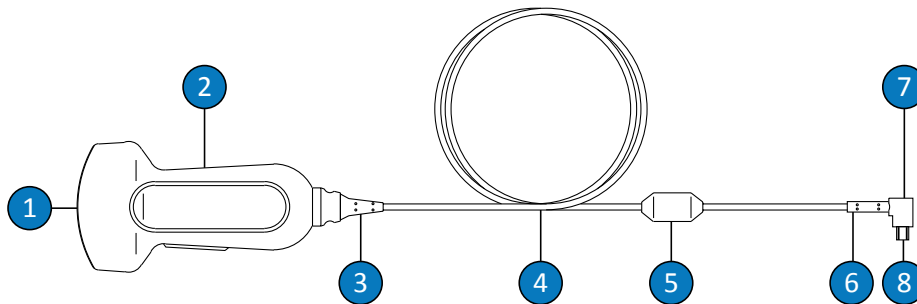

USB Transducer Components

-
- | | |
|-------|-----------------------------------|
| 1 | Transducer lens (acoustic window) |
| <hr/> | |
| 2 | Transducer housing |
| <hr/> | |
| 3 | Transducer strain relief |
| <hr/> | |
| 4 | Cable |
| <hr/> | |
| 5 | Ferrite bead |
-

6	USB connector strain relief
7	USB connector
8	Electrical contacts

Warnings and Cautions for USB Transducers

Observe the following warnings and cautions during all cleaning and disinfection procedures, and when using disinfectants. More specific warnings and cautions are included within the care and cleaning procedures and on the labels of the cleaners or disinfectants.



WARNING

Transducers must be cleaned after each use. Cleaning the transducer is an essential step before effective disinfection or sterilization. Be sure to follow the manufacturer's label instructions when using cleaners and disinfectants.



WARNING

Always use protective eyewear and gloves when cleaning, disinfecting, or sterilizing any equipment.



WARNING

Disinfectants are recommended because of their chemical compatibility with product materials, not their biological effectiveness. For the biological effectiveness of a disinfectant, see the guidelines and recommendations of the disinfectant manufacturer, the U.S. Food and Drug Administration, and the U.S. Centers for Disease Control.

**WARNING**

The level of disinfection required for a device is dictated by the type of tissue it will contact during use and the type of transducer being used. Ensure that the disinfectant type is appropriate for the type of transducer and the transducer application. For information on the levels of disinfection requirements, see [“Transducer Care Methods” on page 43](#). Also, see the disinfectant label instructions and the recommendations of the Association for Professionals in Infection Control, the U.S. Food and Drug Administration, the AIUM Official Statements: "Guidelines for Cleaning and Preparing External- and Internal-Use Ultrasound Transducers Between Patients, Safe Handling, and Use of Ultrasound Coupling Gel," and the U.S. Centers for Disease Control.

**WARNING**

If a pre-mixed solution is used, be sure to observe the solution expiration date.

**WARNING**

Follow the recommendations of the cleaner or disinfectant manufacturer.

**CAUTION**

Using non-recommended disinfectants, using incorrect solution strengths, or immersing a transducer deeper or longer than recommended can damage or discolor the transducer and voids the transducer warranty.

**CAUTION**

The use of isopropyl alcohol (rubbing alcohol), denatured ethyl alcohol, and alcohol-based products on all transducers is limited. On transducers with USB connectors, the only parts that may be cleaned with alcohol are the transducer housing and lens (acoustic window). Ensure that the solution is only 91% or less isopropyl alcohol or 85% or less denatured ethyl alcohol. Do not clean any other part of a transducer with alcohol (including cables, USB connectors, or strain reliefs), because it can damage those parts of the transducer. This damage is not covered by the warranty or your service contract.

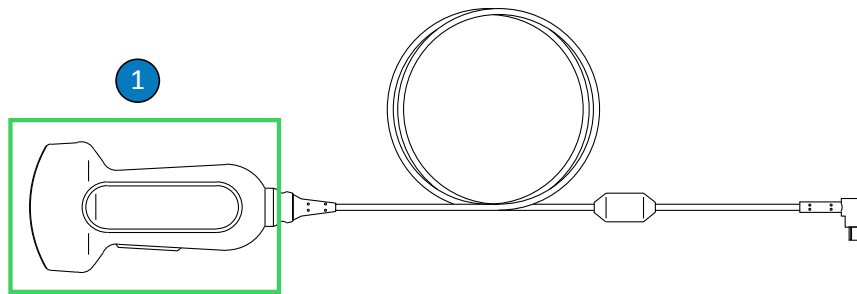
**Alcohol-Compatible Parts of USB Transducers**

- 1 The only parts that may be cleaned with 91% or less isopropyl alcohol solutions or 85% or less denatured ethyl alcohol solutions are the transducer housing and lens (acoustic window). Do not allow fluid to enter any unsealed area of the transducer. When cleaning the lens surface, use a gentle wiping motion. Aggressive wiping or scrubbing can damage the lens.

**CAUTION**

When using an enzymatic cleaner, be sure to use the proper concentration and rinse thoroughly. Enzymatic cleaners are generically approved for use.

**CAUTION**

Attempting to clean or disinfect a transducer, cable, or connector housing by using a method other than the procedures here can damage the device and voids the warranty.

**CAUTION**

Do not allow sharp objects, such as scissors, scalpels, or cauterizing knives, to touch transducers or cables.

**CAUTION**

When handling a transducer, do not bump the transducer on hard surfaces.

**CAUTION**

Do not use a surgeon's brush when cleaning transducers. Even the use of soft brushes can damage transducers.

**CAUTION**

Do not use a brush on the transducer label.

**CAUTION**

Do not use paper products or abrasive products when cleaning a transducer. They damage the soft lens (acoustic window) of the transducer. The use of abrasive industrial wipes such as Wypall X60 can damage the lens.

**CAUTION**

During cleaning, disinfection, and sterilization, orient the parts of the transducer, connector housing, or cable that must remain dry higher than the wet parts, until all parts are dry. This helps keep liquid from entering unsealed areas of the transducer.

**CAUTION**

When cleaning and disinfecting transducers, do not allow any fluid to enter electrical connections or metal portions of the USB connector. Damage due to fluids in these areas is not covered by the warranty or your service contract.

**CAUTION**

To keep fluids from entering the transducer, do not disconnect the USB cable from the transducer during cleaning and disinfection.

**CAUTION**

Do not expose the transducer to cleaning and disinfectant agents for extended periods of time. Limit the time that transducers are exposed to cleaning and disinfectant agents to the minimum time recommended by the manufacturer.

**CAUTION**

Before storing transducers, ensure that they are thoroughly dry. If it is necessary to dry the transducer lens or acoustic window after cleaning, use a soft cloth and a gentle blotting motion. Aggressive wiping or scrubbing can damage the lens.

**CAUTION**

Never sterilize the transducer with autoclave, gamma-radiation, gas, steam, or heat sterilization techniques. Severe damage will result. Avoidable transducer damage is not covered by the warranty or service contract.

Minimizing the Effects of Residual Disinfectant

If you use an OPA (ortho-phthalaldehyde) based disinfectant, residual solution may remain on your transducers if you do not carefully follow the manufacturer's instructions.

To minimize the effects from residual OPA, or any other disinfectant, do the following:

- Follow the disinfectant manufacturer's instructions very carefully. For example, the manufacturer of Cidex OPA recommends rinsing transducers by immersing them three times in potable water.
- Limit the time that transducers are exposed to the disinfectant to the minimum time recommended by the disinfectant manufacturer. For example, the manufacturer of Cidex OPA recommends a minimum of 12 minutes.

Cleaning USB Transducers, Cables, and Connectors

These general cleaning instructions must be followed for all USB transducers, cables, and connectors. All transducers must be cleaned after each use. Cleaning the transducer is an essential step before effective disinfection or sterilization.

Before cleaning a transducer, read the warnings and cautions in the “[Safety](#)” section and “[Warnings and Cautions for USB Transducers](#)” on page 70 and observe the following precautions.

After cleaning, you must disinfect transducers by following the appropriate procedures:

- “[Low-Level Disinfecting USB Transducers](#)” on page 79
- “[High-Level Disinfecting USB Transducers](#)” on page 81
- “[Sterilizing USB Transducers](#)” on page 84

**WARNING**

Always use protective eyewear and gloves when cleaning, disinfecting, or sterilizing any equipment.

**CAUTION**

When cleaning and disinfecting transducers, do not allow any fluid to enter electrical connections or metal portions of the USB connector. Damage due to fluids in these areas is not covered by the warranty or your service contract.

**CAUTION**

To keep fluids from entering the transducer, do not disconnect the USB cable from the transducer during cleaning and disinfection.

Recommended supplies:

- Soft moist cloth or non-abrasive sponge
- Compatible cleaners or cleaning wipes for the transducer, cable, and connector
- Soft, dry, lint-free cloth

1. After every patient study, remove the ultrasound transmission gel from the transducer, cable, and connector by using a soft moist cloth dampened with potable water or an approved cleaning or disinfectant agent or by using an approved pre-saturated cleaning or disinfectant wipe. Use a gentle wiping motion to remove gel from the lens. If applicable, remove the transducer cover.

For a list of compatible cleaning or disinfectant agents, see *Disinfectants and Cleaning Solutions for Ultrasound Systems and Transducers*, which is available with your system documentation or on the "Transducer and System Care" website:

www.philips.com/transducercare

Follow the label instructions for preparation, temperature, solution strength, and duration of contact. Ensure that the solution strength and duration of contact are appropriate for the intended clinical use of the device. If a pre-mixed solution is used, be sure to observe the solution expiration date.

2. Disconnect the transducer from the system, and remove any accessories attached to or covering the transducer. Push the connector cover, if available, onto the connector to protect against fluid splashing onto the contacts.
3. Remove any remaining gel from the transducer and lens by using running water (not to exceed 43°C (110°F)) and a soft sponge or gloved hand. If running water is not available, use a pre-moistened soft cloth, such as a flushable cleansing cloth. Use a gentle wiping motion to remove gel from the lens.
4. To remove any particulate matter or body fluids that remain on the transducer, cable, ferrite bead, or connector, use commercially available cleaning wipes or sponges (enzymatic or non-enzymatic), or a soft cloth lightly dampened in a mild soap. Enzymatic cleaners are generically approved for use.
5. To remove remaining particulate and cleaning residue from the transducer, cable, ferrite bead, or connector, use cleaning wipes according to the manufacturer's instructions. You may rinse the transducer thoroughly with potable water up to the immersion point shown in the figure following this procedure. No other part of the transducer, cable, or connector can be soaked or immersed in fluids.

NOTE

If you use cleaning wipes or sponges, it may be unnecessary to rinse the transducer with water. Always follow the product label instructions.

6. Allow the device to air dry or use a soft, dry, lint-free cloth to dry the transducer. To dry the lens, use a gentle blotting motion. Wet surfaces have the potential of diluting the disinfectant.
7. Examine the device and cable for damage such as cracks, splitting, sharp edges, or projections. If damage is evident, discontinue use of the device and contact your Philips representative.

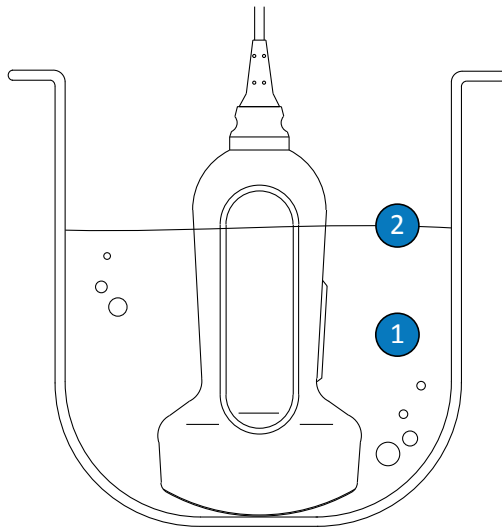

Immersion Point for USB Transducers

- | | |
|---|--|
| 1 | Immerse this portion only. |
| 2 | Maximum allowable immersion depth; you are not required to immerse to this depth if it is unnecessary. |

Low-Level Disinfecting USB Transducers

Low-level disinfection of USB transducers uses the spray or wipe method, with a low-level or intermediate-level disinfectant. Before performing this procedure, read the warnings and cautions in the “[Safety](#)” section and “[Warnings and Cautions for USB Transducers](#)” on page 70 and observe the following precautions.



WARNING

Always use protective eyewear and gloves when cleaning, disinfecting, or sterilizing any equipment.



CAUTION

When cleaning and disinfecting transducers, do not allow any fluid to enter electrical connections or metal portions of the USB connector. Damage due to fluids in these areas is not covered by the warranty or your service contract.



CAUTION

To keep fluids from entering the transducer, do not disconnect the USB cable from the transducer during cleaning and disinfection.

NOTE

Transducers can be disinfected using the wipe method only if the product labeling of the compatible disinfectant you are using indicates it can be used with a wipe method.

Recommended supplies:

- Soft moist cloth or non-abrasive sponge

- Compatible low-level or intermediate-level disinfectants for the transducer, cable, and connector
 - Soft, dry, lint-free cloth
1. Clean the transducer, cable, and connector according to the procedures in “[Cleaning USB Transducers, Cables, and Connectors](#)” on page 75. Observe all warnings and cautions.
 2. After cleaning, choose a low-level or intermediate-level disinfectant that is compatible with the transducer. For a list of compatible disinfectants, see *Disinfectants and Cleaning Solutions for Ultrasound Systems and Transducers*, which is available with your system documentation or on the "Transducer and System Care" website:

www.philips.com/transducercare

Follow the label instructions for preparation, temperature, solution strength, and duration of contact. Ensure that the solution strength and duration of contact are appropriate for the intended clinical use of the device. If a pre-mixed solution is used, be sure to observe the solution expiration date.

NOTE

Some products are labeled as both cleaning and disinfecting wipes. Follow label instructions for both cleaning and disinfection when using these products.

3. Using an appropriate disinfectant for the USB cable and connector, wipe or spray the cable, strain relief, ferrite bead, and USB connector, following disinfectant label instructions for temperature, wipe durations, solution strengths, and duration of disinfectant contact. Ensure that the disinfectant solution does not enter the connector. When disinfecting the USB cable, wipe or spray only the outer surfaces; do not allow any type of fluid to enter through the strain relief, connector, or electrical contacts. Fluid in the connector may void the device warranty.
4. If the disinfectant label instructions require it, rinse with potable water.
5. Allow the device to air dry. You may use a soft, dry, lint-free cloth to dry the transducer. To dry the lens, use a blotting motion instead of a wiping motion.

6. Examine the transducer for damage, such as cracks, splitting, fluid leaks, or sharp edges or projections. If damage is evident, discontinue use of the transducer and contact your Philips representative.

High-Level Disinfecting USB Transducers

High-level disinfection of USB transducers typically uses an immersion method, with high-level disinfectants. Automated reprocessors or other non-immersion methods can be used to disinfect some transducers. For more information, see [“Guidelines for ARs \(Automated Reprocessors\)” on page 45](#). Before performing this procedure, read the warnings and cautions in the [“Safety”](#) section and [“Warnings and Cautions for USB Transducers” on page 70](#) and observe the following precautions.



WARNING

Always use protective eyewear and gloves when cleaning, disinfecting, or sterilizing any equipment.



CAUTION

When cleaning and disinfecting transducers, do not allow any fluid to enter electrical connections or metal portions of the USB connector. Damage due to fluids in these areas is not covered by the warranty or your service contract.



CAUTION

To keep fluids from entering the transducer, do not disconnect the USB cable from the transducer during cleaning and disinfection.

Recommended supplies:

- Soft moist cloth or non-abrasive sponge
 - Compatible high-level disinfectants for the transducer
 - Soaking container
 - Soft, dry, lint-free cloth
1. Clean the transducer, cable, and connector according to the procedures in “[Cleaning USB Transducers, Cables, and Connectors](#)” on page 75. Observe all warnings and cautions.
 2. Disinfect the cable and connector according to the procedures in “[Low-Level Disinfecting USB Transducers](#)” on page 79.
 3. After cleaning, choose a high-level disinfectant that is compatible with the transducer.

For a list of compatible disinfectants, see *Disinfectants and Cleaning Solutions for Ultrasound Systems and Transducers*, which is available with your system documentation or on the "Transducer and System Care" website:

www.philips.com/transducercare

Follow the label instructions for preparation, temperature, solution strength, and duration of contact. Ensure that the solution strength and duration of contact are appropriate for the intended clinical use of the device. If a pre-mixed solution is used, be sure to observe the solution expiration date.

4. If you are using an immersion method:
 - a. Immerse the transducer into the appropriate disinfectant for your transducer as shown in the figure following this procedure. The transducer may be immersed only up to the immersion point shown. No other part of the transducer, cable, strain reliefs, or connector can be soaked or immersed in fluids.
 - b. Follow the instructions on the disinfectant label for the duration of transducer immersion. Do not immerse transducers longer than the minimum time needed for your level of disinfection.
 - c. Using the instructions on the disinfectant label, rinse the transducer up to the point of immersion. Do not soak or immerse any other part of the transducer, cable, strain reliefs, or connector.

5. If you are using a non-immersion method such as an AR, follow the manufacturer's instructions for use for proper cleaning and disinfection.
6. Allow the device to air dry. You may use a soft, dry, lint-free cloth to dry the transducer. To dry the lens, use a blotting motion instead of a wiping motion.
7. Examine the transducer for damage, such as cracks, splitting, fluid leaks, or sharp edges or projections. If damage is evident, discontinue use of the transducer and contact your Philips representative.

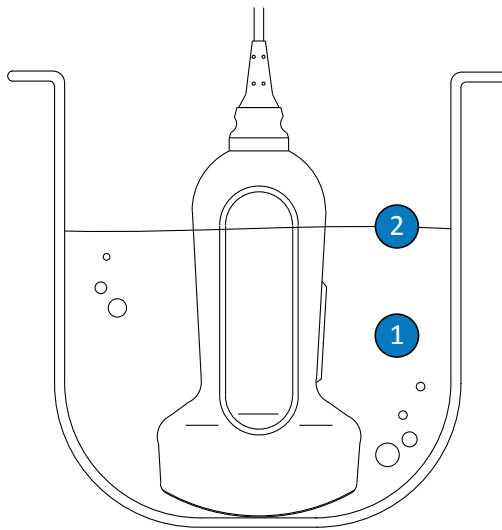

Immersion Point for USB Transducers

- | | |
|---|--|
| 1 | Immerse this portion only. |
| 2 | Maximum allowable immersion depth; you are not required to immerse to this depth if it is unnecessary. |

Sterilizing USB Transducers

The main difference between high-level disinfection and sterilization is the length of time that the transducer is immersed and the type of disinfectant or sterilant used. For sterilization, follow the same procedures as high-level disinfection, but use a compatible sterilant and follow the manufacturer's instructions for preparation, temperature, solution strength, and duration of contact.

TEE Transducer Care

The following topics explain how to clean, disinfect, and sterilize transesophageal echocardiographic (TEE) transducers. To determine the appropriate care method for your transducer, see [“Transducer Care Methods” on page 43](#).

Upon receiving your new transducer, disinfect it before performing the first study. Clean and disinfect the transducer immediately after each use to protect patients and personnel from pathogens. Establish and clearly post a cleaning procedure that includes the steps described in this section.

The following figure identifies the components of a TEE Transducer.

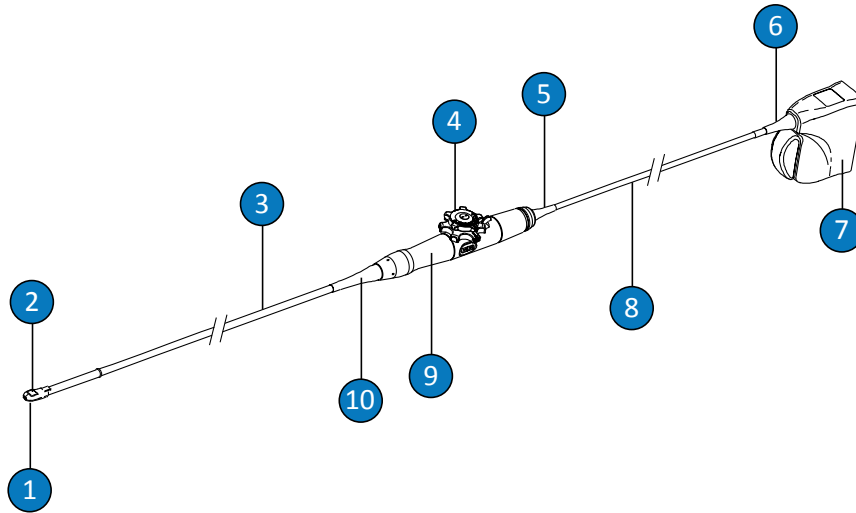

TEE Transducer Components

1	Distal tip
2	Transducer lens (acoustic window)
3	Flexible shaft
4	Transducer controls
5	Control housing (handle) strain relief
6	Connector strain relief
7	Connector housing
8	Cable
9	Control housing (handle)
10	Control housing (handle) strain relief

4535 620 14051_A/795 * JUL 2019

Philips

Warnings and Cautions for TEE Transducers

Observe the following warnings and cautions during all cleaning, disinfection, and sterilization procedures, and when using disinfectants. More specific warnings and cautions are included within the care and cleaning procedures and on the labels of the cleaners or disinfectants.



WARNING

Transducers must be cleaned after each use. Cleaning the transducer is an essential step before effective disinfection or sterilization. Be sure to follow the manufacturer's label instructions when using cleaners and disinfectants.



WARNING

Always use protective eyewear and gloves when cleaning, disinfecting, or sterilizing any equipment.



WARNING

Sterile transducer covers with sterile ultrasound transmission gel are required for intraoperative and biopsy procedures. Protective covers are recommended for transesophageal, transrectal, and intravaginal procedures; in China and Japan, the covers are mandatory. Philips recommends the use of qualified covers.



WARNING

Sterile transducer covers are disposable and must not be reused.

**WARNING**

Bite guards are mandatory for TEE transducers.

**WARNING**

Disinfectants are recommended because of their chemical compatibility with product materials, not their biological effectiveness. For the biological effectiveness of a disinfectant, see the guidelines and recommendations of the disinfectant manufacturer, the U.S. Food and Drug Administration, and the U.S. Centers for Disease Control.

**WARNING**

The level of disinfection required for a device is dictated by the type of tissue it will contact during use and the type of transducer being used. Ensure that the disinfectant type is appropriate for the type of transducer and the transducer application. For information on the levels of disinfection requirements, see [“Transducer Care Methods” on page 43](#). Also, see the disinfectant label instructions and the recommendations of the Association for Professionals in Infection Control, the U.S. Food and Drug Administration, the AIUM Official Statements: "Guidelines for Cleaning and Preparing External- and Internal-Use Ultrasound Transducers Between Patients, Safe Handling, and Use of Ultrasound Coupling Gel," and the U.S. Centers for Disease Control.

**WARNING**

When sterilizing a transducer, ensure that the sterilant's strength and duration of contact are appropriate for sterilization. Be sure to follow the manufacturer's instructions.

**WARNING**

If a pre-mixed solution is used, be sure to observe the solution expiration date.

**WARNING**

Follow the recommendations of the cleaner or disinfectant manufacturer.

**CAUTION**

Never sterilize the transducer with autoclave, gamma-radiation, gas, steam, or heat sterilization techniques. Severe damage will result. Avoidable transducer damage is not covered by the warranty or service contract.

**CAUTION**

Using non-recommended disinfectants, using incorrect solution strengths, or immersing a transducer deeper or longer than recommended can damage or discolor the transducer and voids the transducer warranty.

**CAUTION**

The use of isopropyl alcohol (rubbing alcohol), denatured ethyl alcohol, and alcohol-based products on all transducers is limited. On TEE transducers, the only parts that may be cleaned with alcohol are the connector housing and the control housing. Ensure that the solution is only 91% or less isopropyl alcohol or 85% or less denatured ethyl alcohol. Do not clean any other part of a transducer with alcohol (including cables or strain reliefs), because it can damage those parts of the transducer. This damage is not covered by the warranty or your service contract.

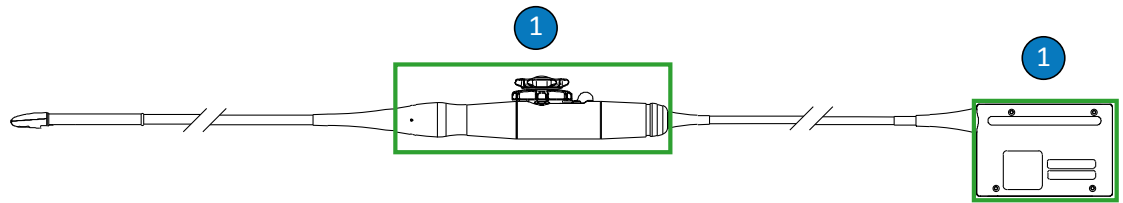

Alcohol-Compatible TEE Transducer Parts

- 1 The only parts that may be cleaned with 91% or less isopropyl alcohol solutions or 85% or less denatured ethyl alcohol solutions are the connector housing and control housing. Do not allow fluid to enter any unsealed area of the transducer.



CAUTION

When using an enzymatic cleaner, be sure to use the proper concentration and rinse thoroughly. Enzymatic cleaners are generically approved for use.



CAUTION

Do not use bleach on the transducer and shaft.



CAUTION

Attempting to clean or disinfect a transducer, cable, or connector housing by using a method other than the procedures here can damage the device and voids the warranty.



CAUTION

Do not allow sharp objects, such as scissors, scalpels, or cauterizing knives, to touch transducers or cables.

**CAUTION**

When handling a transducer, do not bump the transducer on hard surfaces.

**CAUTION**

On TEE transducers, do not crimp the flexible shaft or cable. Do not bend the shaft into a circle with a diameter of less than 0.3 m (1 ft).

**CAUTION**

Do not use a surgeon's brush when cleaning transducers. Even the use of soft brushes can damage transducers.

**CAUTION**

Do not use a brush on the connector housing label.

**CAUTION**

Do not use paper products or abrasive products when cleaning a transducer. They damage the soft lens (acoustic window) of the transducer. The use of abrasive industrial wipes such as Wypall X60 can damage the lens.

**CAUTION**

During cleaning, disinfection, and sterilization, orient the parts of the transducer, connector housing, or cable that must remain dry higher than the wet parts, until all parts are dry. This helps keep liquid from entering unsealed areas of the transducer.

**CAUTION**

When cleaning and disinfecting transducers, do not allow any fluid to enter the connector through the electrical contacts, strain reliefs, connector housing, or areas surrounding the locking lever shaft. Do not allow any fluid to enter the handle or steering mechanism. When wiping or spraying the connector or handle housings, wipe or spray only the outer surfaces. If available, place a connector-cover splash guard over the electrical contacts to help prevent fluid from entering the connector housing. Damage due to fluids in these areas is not covered by the warranty or your service contract.

**CAUTION**

Do not expose the transducer to cleaning and disinfectant agents for extended periods of time. Limit the time that transducers are exposed to cleaning and disinfectant agents to the minimum time recommended by the manufacturer.

**CAUTION**

The transducer steering mechanism for TEE transducers is unsealed. If disinfectant or other fluid enters the steering mechanism, it corrodes the gears and electrical connections. Avoidable transducer damage is not covered by the warranty or service contract.

**CAUTION**

Do not rinse or immerse the TEE transducer handle, steering mechanism, cable, connector, or strain reliefs.

**CAUTION**

Before storing transducers, ensure that they are thoroughly dry. If it is necessary to dry the transducer lens (acoustic window) after cleaning, use a soft, dry, lint-free cloth and a gentle blotting motion. Aggressive wiping or scrubbing can damage the lens.

Minimizing the Effects of Residual Disinfectant

If you use an OPA (ortho-phthalaldehyde) based disinfectant, residual solution may remain on your transducers if you do not carefully follow the manufacturer's instructions.

**WARNING**

Residual OPA on TEE transducers may cause temporary staining of the mouth and lip area and irritation or chemical burns of the mouth, throat, esophagus, and stomach.

To minimize the effects from residual OPA, or any other disinfectant, do the following:

- Follow the disinfectant manufacturer's instructions very carefully. For example, the manufacturer of Cidex OPA recommends rinsing transducers by immersing them three times in potable water.
- Limit the time that transducers are exposed to the disinfectant to the minimum time recommended by the disinfectant manufacturer. For example, the manufacturer of Cidex OPA recommends a minimum of 12 minutes.

S7-3t and S8-3t Cautions

Because of their small size, the S7-3t and S8-3t transducers are very delicate electronic instruments. To avoid damaging the transducers, observe the following cautions.

**CAUTION**

When wiping the distal tip of the S7-3t or the S8-3t transducer, never apply excessive force to the lens (acoustic window). Gently wipe the tip with a moist cloth. Do not squeeze the lens, the acoustic window, or the tip, because this may damage the transducer.

**CAUTION**

Do not allow sharp objects, such as scissors, scalpels, or cauterizing knives, to touch transducers or cables.

**CAUTION**

Articulate the tip only with the controls; do not articulate it with your hand.

**CAUTION**

Do not bend or crimp the flexible shaft or cable.

**CAUTION**

When handling a transducer, do not bump the transducer on hard surfaces.

Guidelines for TEE Transducers

The guidelines provided here are intended for Philips TEE transducers.

High-level disinfection or sterilization is the accepted method of infection control for TEE transducers. Sterilization is required if the transducer enters otherwise sterile tissue without a sterile cover. If you use a sterile cover, sterilization is still recommended, but high-level disinfection is acceptable. The main difference between sterilization and high-level disinfection is the length of time that the transducer is immersed and the type of disinfectant or sterilant used.

To determine if your transducer requires high-level disinfection or sterilization, see [“Transducer Care Methods” on page 43](#).

High-level disinfection or sterilization of TEE transducers is typically performed by immersion or by using an automated TEE transducer disinfectant or an automated TEE cleaner disinfectant. Before either disinfection or sterilization, thorough cleaning of the device is required.



CAUTION

Never sterilize the transducer with autoclave, gamma-radiation, gas, steam, or heat sterilization techniques. Severe damage will result. Avoidable transducer damage is not covered by the warranty or service contract.

NOTE

Some high-level disinfectants do not require immersion and are compatible with TEE transducers. For compatible high-level disinfectants, see *Disinfectants and Cleaning Solutions for Ultrasound Systems and Transducers*. If you choose to use those disinfectants, always follow the manufacturer's instructions for use. Follow the procedures in this manual that correspond to the “Qualified Use” disinfection method for the selected disinfectant, as defined in *Disinfectants and Cleaning Solutions for Ultrasound Systems and Transducers*, which is available with your system documentation or on the “Transducer and System Care” website: www.philips.com/transducercare

NOTE

Enzymatic cleaners are generically approved for use.

The TEE transducer handle and connector are not patient-contacting and do not require the same level of disinfection as the patient-contacting flexible shaft and distal tip. Therefore, separate procedures are provided for disinfecting/sterilizing the patient contacting and non-patient contacting parts. Adhering to these procedures is critical to ensuring the long term reliability of the device.

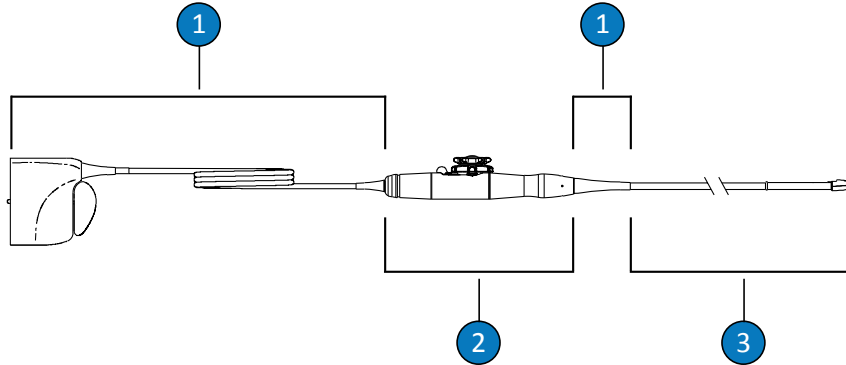

TEE Transducer Parts

1	C (Cable, connector, and strain reliefs)
2	H (Handle and steering mechanism)
3	T (Transducer: flexible shaft and distal tip)

Summary of Parts to Clean and Disinfect on a TEE Transducer

The following illustration provides a summary of the parts to clean and disinfect on a TEE transducer. For the full procedure, see [“Cleaning and Disinfecting TEE Transducers” on page 96.](#)

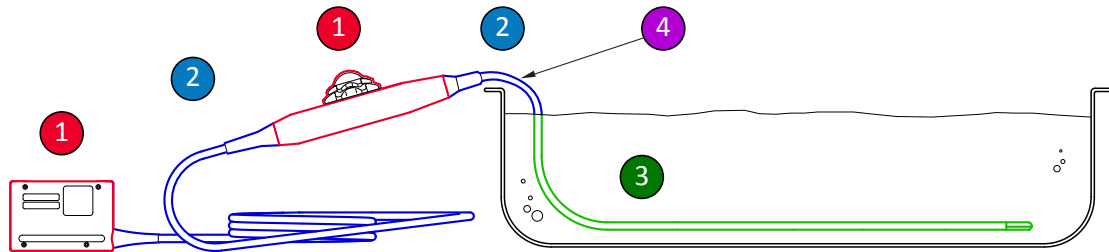

Parts to Clean and Disinfect on a TEE Transducer

1 and 2	Spray and wipe these parts of the transducer with disinfectants that are compatible with the various parts. Do not immerse or rinse these parts; do not allow fluid to enter any unsealed opening.
1	If you want to use alcohol, only the outside of the control (handle) housing and connector housing are compatible with 91% isopropyl alcohol solutions or 85% denatured ethyl alcohol solutions. Lightly wipe with a pad moistened with the alcohol. Do not immerse or rinse these parts; do not allow fluid to enter any unsealed opening.
3	Only the flexible shaft can be immersed or rinsed. Soak for the minimum time recommended by the disinfectant manufacturer; do not immerse deeper or longer than recommended.
4	Immerse only to within 5 cm (2 in) from the strain relief; this is the maximum allowable immersion of the cable – you are not required to immerse to this point if it is not necessary.

Cleaning and Disinfecting TEE Transducers

Before performing these procedures, read the warnings and cautions in the [“Safety”](#) section and [“Warnings and Cautions for TEE Transducers”](#) on page 86.

To clean and disinfect or sterilize a TEE transducer, you must use the following procedures:

- [“Cleaning the TEE Transducer, Cable, Connector, and Handle”](#) on page 97
- [“Low-Level Disinfecting TEE Cable, Connector, and Handle”](#) on page 101

- “High-Level Disinfecting and Sterilizing TEE Transducers (Flexible Shaft and Distal Tip)” on page 102

Begin by choosing the cleaners and disinfectants or sterilants that are compatible with the different parts of your transducer. Ensure that the solution strength and duration of contact are appropriate for the intended clinical use of the device. Follow the manufacturer's label instructions for preparation and solution strength. If pre-mixed solutions are used, be sure to observe the solution expiration date.

For a list of cleaners, disinfectants, and sterilants that are compatible with the transducer, see *Disinfectants and Cleaning Solutions for Ultrasound Systems and Transducers*, which is available with your system documentation or on the “Transducer and System Care” website:

www.philips.com/transducercare

Follow the label instructions for preparation, temperature, solution strength, and duration of contact. Ensure that the solution strength and duration of contact are appropriate for the intended clinical use of the device. If a pre-mixed solution is used, be sure to observe the solution expiration date.

NOTE

Some products are labeled as both cleaning and disinfecting wipes. Follow label instructions for both cleaning and disinfection when using these products.

Cleaning the TEE Transducer, Cable, Connector, and Handle

Recommended supplies:

- Soft moist cloth or non-abrasive sponge
- Compatible cleaners for the transducer, handle, cable, and connector
- Soaking and rinsing trays (if required)
- Soft, dry, lint-free cloth

1. After every patient study, disconnect the transducer from the system, and remove any accessories attached to or covering the transducer.
2. Push the connector cover, if available, onto the connector to protect against fluid splashing onto the contacts.
3. Clean the cable, connector, and handle. See [“Cleaning the Cable, Connector, and Handle of TEE Transducers” on page 98](#).
4. Clean the transducer by using one of the following procedures:
 - [“Cleaning the TEE Transducer by Immersion” on page 99](#)
 - [“Cleaning the TEE Transducer with Sprays or Wipes” on page 100](#)

Cleaning the Cable, Connector, and Handle of TEE Transducers

1. Remove any debris, residual gel, and body fluids from the cable, connector, and handle by using a soft moist cloth dampened with potable water or an approved cleaning or disinfectant agent or by using an approved pre-saturated cleaning or disinfectant wipe. Gently wipe each part until clean.



CAUTION

Do not allow any fluid to enter the handle or steering mechanism and do not allow any fluid to enter the connector through the electrical contacts, strain reliefs, connector housing, or areas surrounding the locking lever shaft.

2. Allow the parts to air dry, or use a soft, dry, lint-free cloth to dry the cable, connector and handle. Wet surfaces have the potential of diluting the disinfectant.

The cable, connector, and handle are ready for low-level disinfection using a low or intermediate-level disinfectant (LLD/ILD). See [“Low-Level Disinfecting TEE Cable, Connector, and Handle” on page 101](#).

Cleaning the TEE Transducer by Immersion

1. Remove any debris, residual gel, and body fluids from the device by using a soft moist cloth dampened with potable water or an approved cleaning or disinfectant agent or by using an approved pre-saturated cleaning or disinfectant wipe. Use a gentle wiping motion to remove gel from the lens. If applicable, remove the transducer cover.
2. Remove any remaining gel from the transducer and lens by using running water (not to exceed 43°C (110°F)) and a soft sponge or gloved hand. If running water is not available, use a pre-moistened soft cloth, such as a flushable cleansing cloth. Use a gentle wiping motion to remove gel from the lens.
3. In a soaking tray, prepare a cleaner that is compatible with your transducer (flexible shaft and distal tip) to the concentration prescribed by the manufacturer.
4. To clean the transducer, immerse only the flexible shaft and distal tip into the cleaning solution, ensuring that the handle and connector are secure. Immerse only to within 5 cm (2 in) from the strain relief; this is the maximum allowable immersion of the flexible shaft. You are not required to immerse to this point if it is not necessary.



CAUTION

Do not immerse the connector or the handle in the prepared solution. These parts are not waterproof or splash-proof.

5. Allow the transducer shaft and distal tip to be exposed to the cleaning solution for the minimum duration recommended by the manufacturer.
6. Unless the manufacturer's instructions for use state that rinsing with water is not required, remove the transducer from the cleaning solution and rinse the transducer shaft and distal tip thoroughly with running water or by immersing in warm water to remove the remaining cleaning solution. The water temperature should be from 32°C to 43°C (90°F to 110°F).

**CAUTION**

Do not immerse or expose the connector or the handle to running water. These parts are not waterproof or splash-proof.

7. Allow the device to air dry, unless the manufacturer's instructions for use specifically state that drying is not required for the decontamination method used, or use a soft, dry, lint-free cloth to dry the transducer. Wet surfaces have the potential of diluting the disinfectant.

The transducer is ready for high-level disinfection using a high-level disinfectant (HLD), or for sterilization using a sterilant (S). See [“High-Level Disinfecting and Sterilizing TEE Transducers \(Flexible Shaft and Distal Tip\)”](#) on page 102.

Cleaning the TEE Transducer with Sprays or Wipes

1. Remove any debris, residual gel, and body fluids from the device by using a soft moist cloth dampened with potable water or an approved cleaning or disinfectant agent or by using an approved pre-saturated cleaning or disinfectant wipe. Use a gentle wiping motion to remove gel from the lens. If applicable, remove the transducer cover.
2. Remove any remaining gel from the transducer flexible shaft, distal tip, and lens by using running water (not to exceed 43°C (110°F)) and a soft sponge or gloved hand. If running water is not available, use a pre-moistened soft cloth, such as a flushable cleansing cloth. Use a gentle wiping motion to remove gel from the lens.
3. Remove any particulate matter or body fluids that remain on the transducer using commercially available cleaning wipes or sponges (enzymatic or non-enzymatic), or a soft cloth lightly dampened in a mild soap. Enzymatic cleaners and mild soaps are generically approved for use. Use a gentle wiping motion to clean the lens.

**CAUTION**

Do not immerse or expose the connector or the handle to running water. These parts are not waterproof or splash-proof.

4. Unless the manufacturer's instructions for use state that rinsing with water is not required, rinse the transducer flexible shaft and distal tip thoroughly with running water or by immersing in warm water to remove the remaining cleaning solution. The water temperature should be from 32°C to 43°C (90°F to 110°F).
5. Allow the device to air dry, unless the manufacturer's instructions for use specifically state that drying is not required for the decontamination method used, or use a soft, dry, lint-free cloth to dry the transducer. Wet surfaces have the potential of diluting the disinfectant.

The transducer is ready for high-level disinfection using a high-level disinfectant (HLD), or for sterilization using a sterilant (S). See [“High-Level Disinfecting and Sterilizing TEE Transducers \(Flexible Shaft and Distal Tip\)”](#) on page 102.

Low-Level Disinfecting TEE Cable, Connector, and Handle

Recommended supplies:

- LLD/ILD sprays or pre-saturated wipes that are compatible for the cable, connector, and handle.
 - Soft, dry, lint-free cloths
1. Wipe the cable, connector, and handle using appropriate compatible wipes pre-saturated with approved LLDs/ILDs. If using a spray, spray onto a cloth and then wipe the cable, connector, and handle using the damp cloth.

**CAUTION**

Do not spray disinfectants directly onto either the handle or the connector.

**CAUTION**

Do not allow any fluid to enter the handle or steering mechanism, and do not allow any fluid to enter the connector through the electrical contacts, strain reliefs, connector housing, or areas surrounding the locking lever shaft.

2. Follow the manufacturer guidelines for the time required to ensure appropriate levels of disinfection.
3. Use a soft, dry, lint-free cloth to wipe the cable, connector, and handle to remove the remaining disinfectant.

The cable, connector, and handle are now disinfected. Continue with disinfection or sterilization of the transducer. See [“High-Level Disinfecting and Sterilizing TEE Transducers \(Flexible Shaft and Distal Tip\)”](#) on page 102.

High-Level Disinfecting and Sterilizing TEE Transducers (Flexible Shaft and Distal Tip)

Recommended supplies:

- Compatible high-level disinfectant (HLD) or sterilant (S)
- Soaking and rinsing trays or an automated TEE transducer disinfectant or automated TEE transducer cleaner disinfectant
- Soft, dry, lint-free cloth (for high-level disinfection procedure)
- Soft, dry, lint-free, sterile cloth (for sterilization procedure)

NOTE

Some high-level disinfectants do not require immersion and are compatible with TEE transducers. For compatible high-level disinfectants, see *Disinfectants and Cleaning Solutions for Ultrasound Systems and Transducers*. If you choose to use those disinfectants, always follow the manufacturer's instructions for use. Follow the procedures in this manual that correspond to the "Qualified Use" disinfection method for the selected disinfectant, as defined in *Disinfectants and Cleaning Solutions for Ultrasound Systems and Transducers*, which is available with your system documentation or on the "Transducer and System Care" website: www.philips.com/transducercare

NOTE

An automated TEE transducer disinfectant or automated TEE transducer cleaner disinfectant can be used for disinfection. Ensure that the selected protocol includes a rinse cycle and a drying step.

1. Read the label of the HLD or S solution to confirm efficacy and ensure that the solution has not expired.
2. In a soaking tray, prepare the HLD or S solution according to the manufacturer's instructions. If you are using an automated TEE transducer disinfectant or automated TEE transducer cleaner disinfectant, prepare the HLD or S solution and program the automated TEE transducer disinfectant or automated TEE transducer cleaner disinfectant according to the manufacturer's instructions.
3. Position the transducer in the soaking tub or automated TEE transducer disinfectant or automated TEE transducer cleaner disinfectant, ensuring that the connector and handle are not at risk of being exposed to the solution during reprocessing. The solutions must not contact the connector and handle during either disinfection or rinsing.
4. Soak or reprocess the transducer for the prescribed length of time.

**CAUTION**

Do not immerse or expose the connector or the handle to running water. These parts are not waterproof or splash-proof.

5. If you soaked the transducer (did not use an automated TEE transducer disinfectant or automated TEE transducer cleaner disinfectant), rinse the transducer thoroughly with running water or by immersing in warm water to remove the remaining disinfectant solution. The water temperature should be from 32°C to 43°C (90°F to 110°F). Follow the disinfectant or sterilant manufacturer's guidelines to assure complete removal of residual solution.
6. If required, allow the transducer to air dry, or dry the transducer using a soft, dry, lint-free cloth or a soft, dry, lint-free, sterile cloth.

NOTE

Some automated reprocessors do not use water-based methods, and therefore, drying is not required.

7. Examine the transducer for damage, such as cracks, splitting, fluid leaks, or sharp edges or projections. If damage is evident, discontinue use of the transducer and contact your Philips representative.
8. Store the transducer in a well-ventilated area, with the handle and connector supported and positioned above the transducer. This aids with drying and reduces the risk of residual fluids from the transducer draining into the handle and connector.

The TEE transducer is now disinfected or sterile and is ready to be used.

Ultrasound Transmission Gels

For proper transmission of the acoustic beam, use the ultrasound transmission gel supplied by or recommended by Philips, or another glycol-, glycerol-, or water-based acoustic coupling medium.



WARNING

For intraoperative applications, use only the Sterile Aquasonic or sterile Ultra Phonic gel provided with the transducer cover.



CAUTION

Do not use lotion-based products, mineral oil, or water-based gels that contain mineral oil. Such products may damage the transducer and void the warranty.



CAUTION

Do not use hand sanitizing gels.



CAUTION

Do not apply the transducer gel until you are ready to perform the procedure. Transducers should not be left soaking in gel.



CAUTION

Gels listed here are recommended because of their chemical compatibility with product materials.

Some recommended gels include:

- Aquasonic 100
- Aquasonic Clear
- Carbogel-ULT
- EcoVue
- Scan
- Ultra Phonic

For additional compatibility information, call Philips at 800-722-9377 (North America) or your local Philips representative (outside North America).

6 Transducer Storage and Transport

Use the appropriate guidelines for storing transducers for transport, and daily and long-term storage.

Transducer Transport

Transport used transducers in a spill-proof, closed container with appropriate contamination labeling. Ensure that the container holds the transducer in place, to avoid damage to the lens. During transportation, prevent all patient-contact parts from contacting non-patient-contact parts.

When you transport cleaned and disinfected transducers, ensure that any containers used for transport are also cleaned and disinfected before you place the clean transducers in the containers.

Storage for Transport

If a carrying case is provided with your transducer, always use the carrying case to transport the transducer from one site to another. Follow these guidelines to properly store transducers for transport:

- Make sure that the transducer is clean and disinfected before placing it in the case to avoid contaminating the foam that lines the carrying case.
- Place the transducer in the case carefully to prevent kinking of the cable.
- Before closing the lid, make sure no part of the transducer is protruding from the case.
- Wrap the case in plastic material containing sealed-air pockets (such as Bubble Wrap material), and pack the wrapped case in a cardboard carton.
- To avoid damaging the shaft or steering mechanism of TEE transducers, do not bend or coil the flexible shaft of the transducer in less than a 0.3-m (1-ft) diameter circle.

Daily and Long-Term Storage

Follow these guidelines to protect your transducer:

- Always store transducers in the transducer holders on the side of your system or on a securely mounted wall rack when you are not using them.
- Ensure the transducer holders are clean before storing transducers (see the [“System Cleaning and Maintenance”](#) section).
- When storing transducers, use the cable-management clips, if available, to secure the transducer cable.
- Avoid storing transducers in areas of temperature extremes or in direct sunlight.
- Store transducers separately from other instruments to avoid inadvertent transducer damage.
- Before storing transducers, make sure they are thoroughly dry.
- For TEE transducers, be sure the distal tip is straight and protected before storing the transducer.
- Never store a TEE transducer in the carrying case, except to transport it.

www.philips.com/healthcare



Philips Ultrasound, Inc.
22100 Bothell Everett Highway
Bothell, WA 98021-8431
USA



Philips Medical Systems Nederland B.V.
Veenpluis 4-6
5684 PC Best
The Netherlands

CE₂₇₉₇



© 2019 Koninklijke Philips N.V.

All rights are reserved. Reproduction or transmission in whole or in part, in any form or by any means, electronic, mechanical or otherwise, is prohibited without the prior written consent of the copyright owner.

Published in USA
4535 620 14051_A/795 * JUL 2019 - en-US